

Hold 1	Skive 1	Trine Weinreich			
Aalborg		Vester Hassing Skytteforening	BK S		
02.03.2018		Nordjysk mesterskab Finaler	Aalborg Skyttekreds		
Prøve		1: 9.6 ↑ 2: 9.9 ↑ 3: 9.9 ↑ 4: 10.8x ↘ 5: 10.0 ↗ 6: 10.7x ↗ 7: 10.3 ↑ 8: 10.2 ↖ 9: 10.5x ↗ 10: 10.4 ↖	Prøve		11: 10.7x ↙ 12: 10.6x ↓ 13: 10.5 ↑ 14: 10.7x ↖
		Serie 102.3	Serie 42.5		
		Total 400.0	Total 400.0		
1. Serie Finale		1: 10.4 ↘ 2: 10.4 ↓ 3: 10.7x ↙ 4: 10.8x ← 5: 10.5 ↖	2. Serie Finale		1: 10.7x ↙ 2: 10.4 ↑ 3: 10.5 ↗ 4: 10.8x ↓ 5: 10.5x ↙
		Serie 52.8	Serie 52.9		
		Total 452.8	Total 505.7		
Omsk.		1: 10.8x ↖ 2: 10.9x ↖ 3: 9.8 →			
		Serie 31.5			
		Total 505.7			

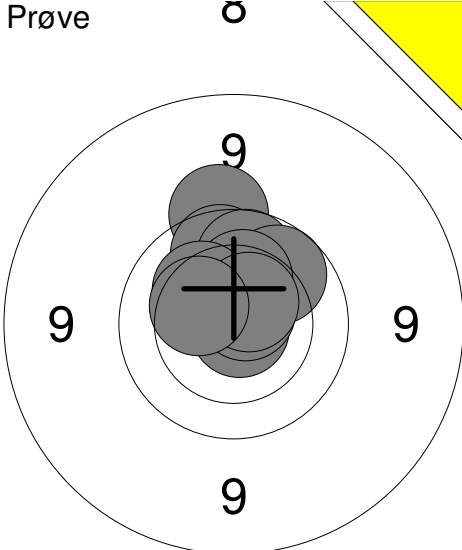

1: 9.9 →	6: 10.7x ↓	Serie	104.5
2: 10.6x ↗	7: 10.6x ↗		
3: 10.6x →	8: 10.2 ↗	Total	400.0
4: 10.7x →	9: 10.3 ↗		
5: 10.2 →	10: 10.7x ←		

11: 10.4 ↓	Serie	10.4
Total		400.0

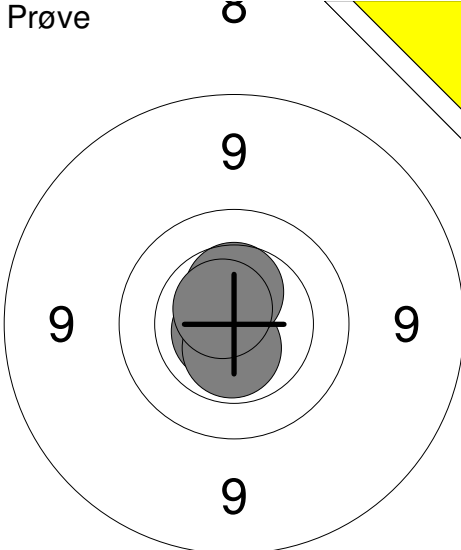
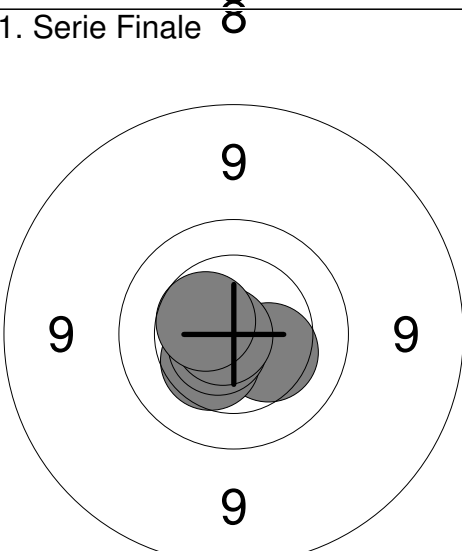
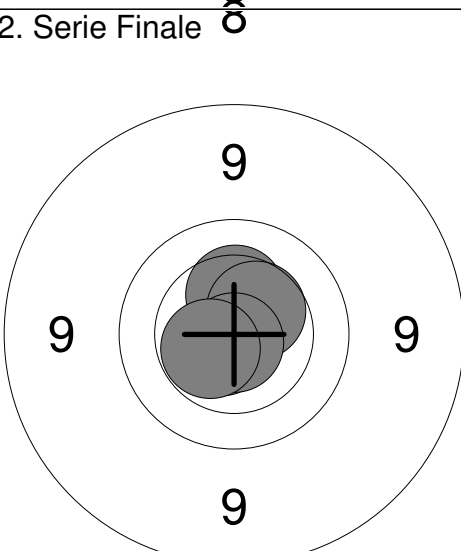
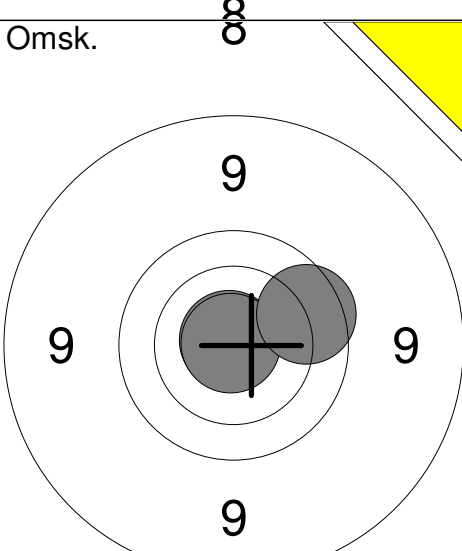
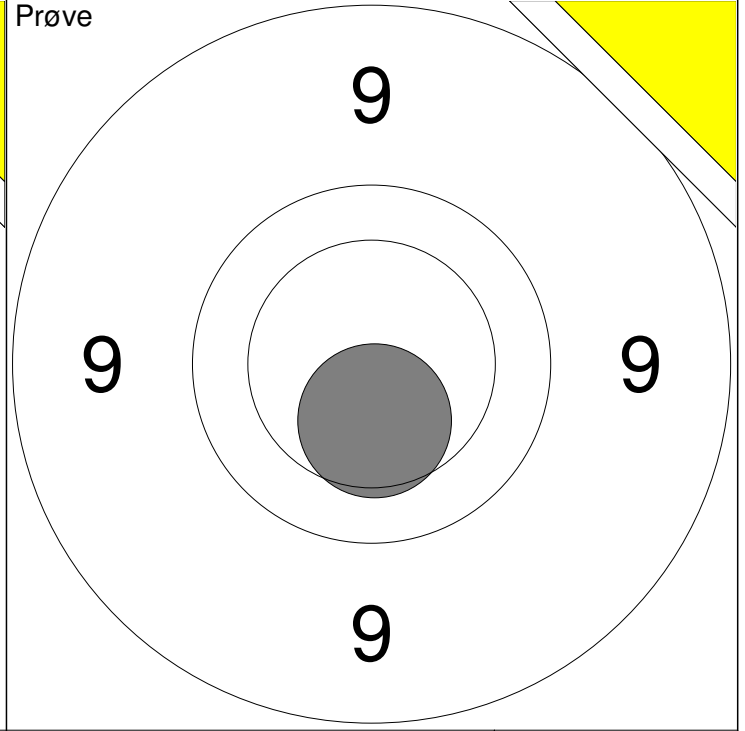
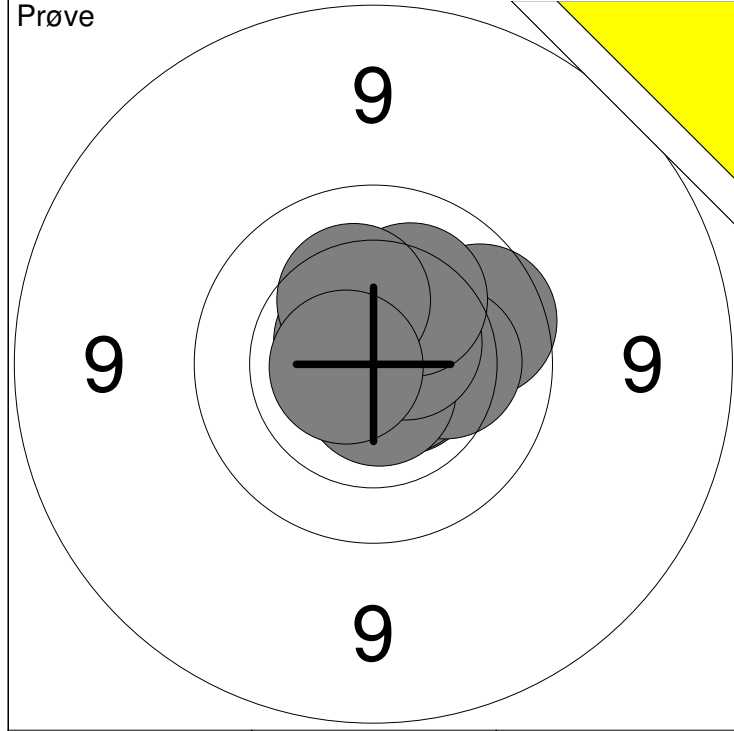
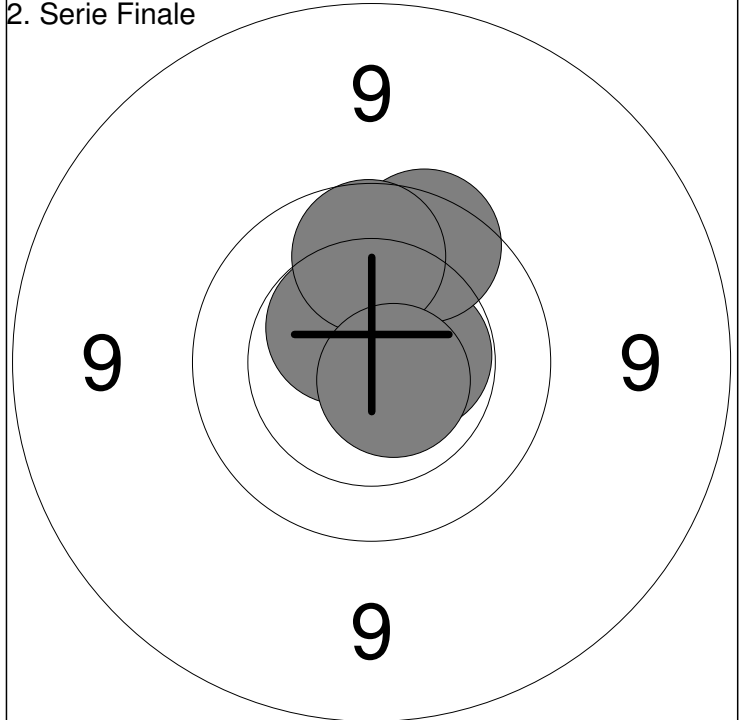
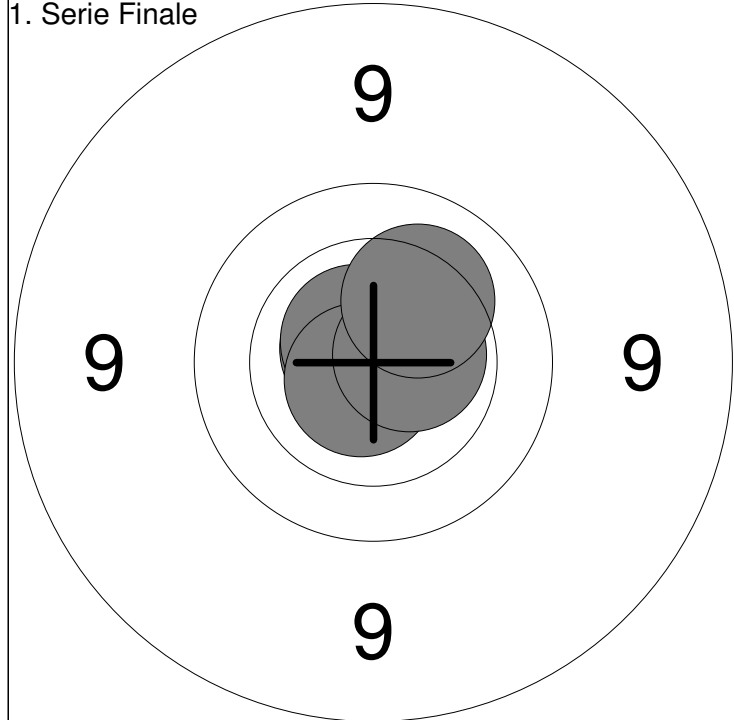

1: 10.7x ↗	Serie	52.9
2: 10.7x ↗		
3: 10.7x ↘	Total	452.9
4: 10.6x →		
5: 10.2 ↗		

1: 10.5x ↗	Serie	51.4
2: 10.5x →		
3: 9.8 ↗	Total	504.3
4: 9.9 ↗		
5: 10.7x ↘		

Hold 1	Skive 3	Emil Hedemann
------------------	-------------------	----------------------

Aalborg	Vester Hassing Skytteforening	BK	S
---------	-------------------------------	----	---

02.03.2018	Nordjysk mesterskab Finaler	Aalborg Skyttekreds
------------	-----------------------------	---------------------

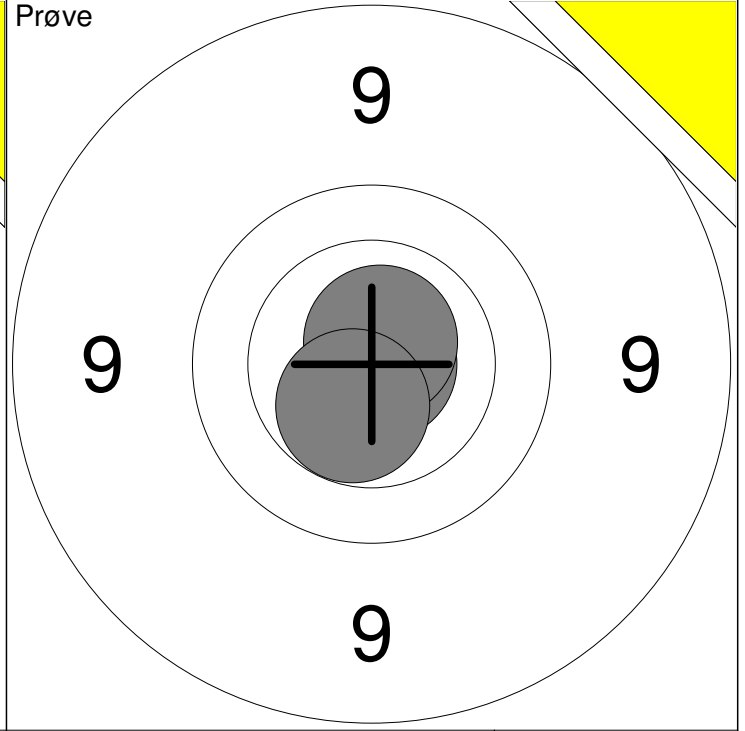
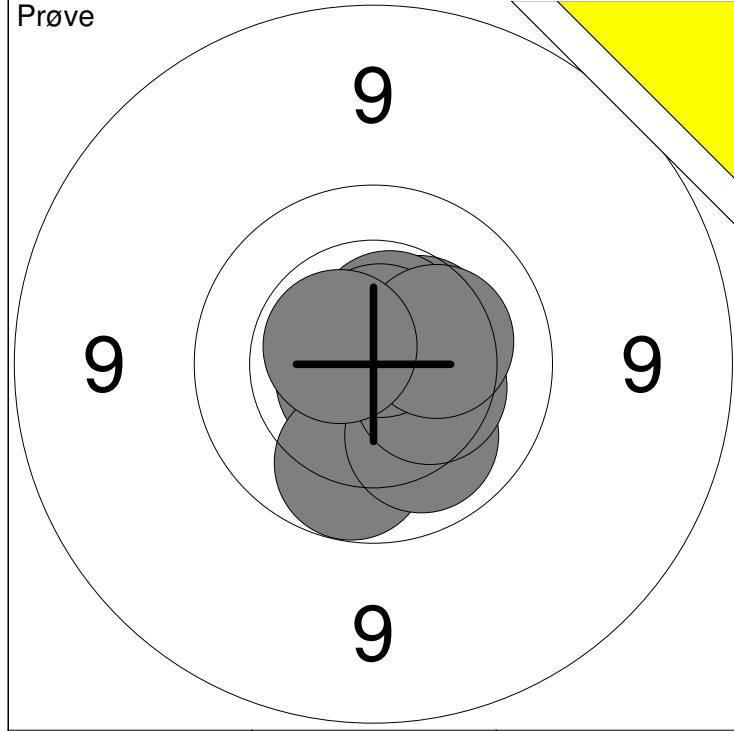

1: 10.7x ↙	6: 10.4 ↗	Serie	104.4
2: 10.7x ↑	7: 10.6x ↗		
3: 10.0 ↓	8: 10.7x ↗	Total	400.0
4: 10.1 ↘	9: 10.3 ↗		
5: 10.3 ↘	10: 10.6x ↙		

11: 10.9x →	Serie	32.1
12: 10.7x ↗		
13: 10.5x ↘	Total	400.0

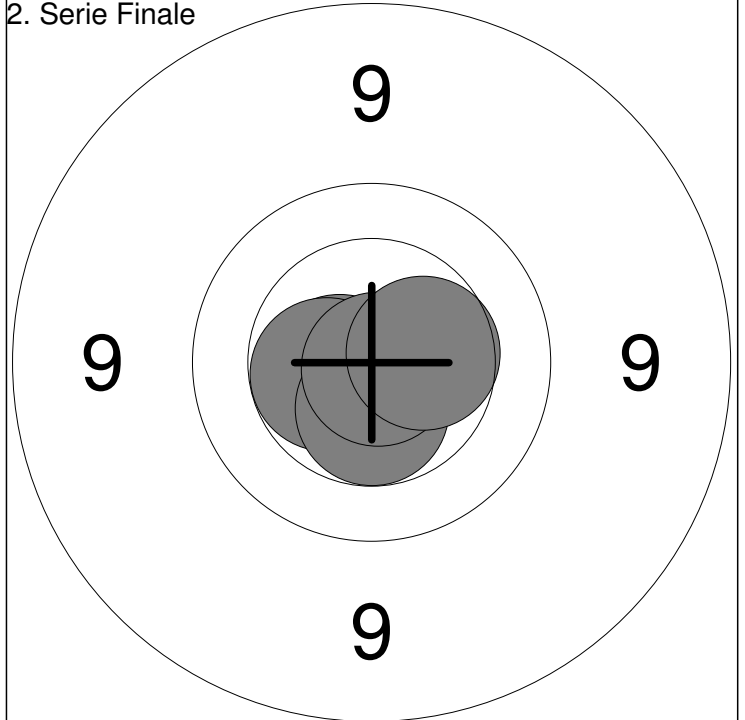
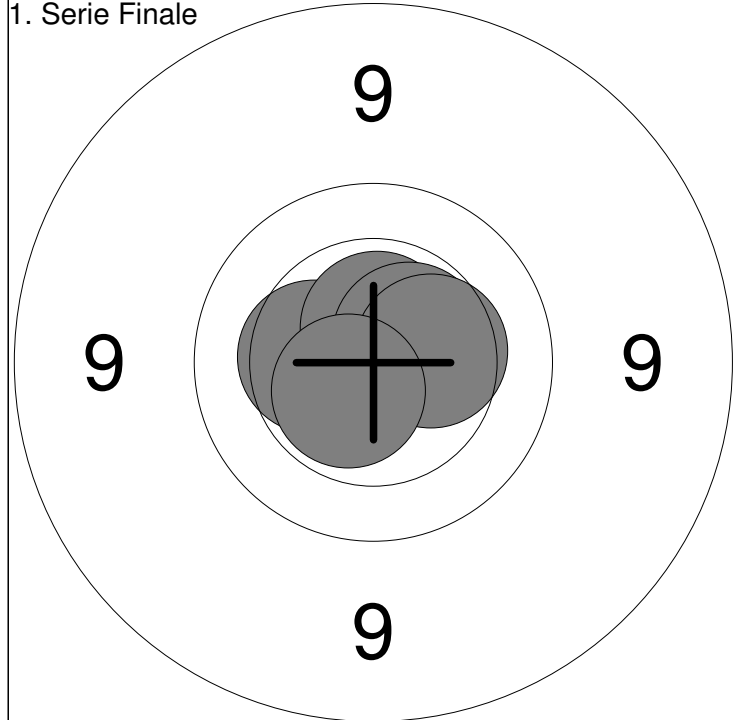

1: 10.4 ←	Serie	52.5
2: 10.6x ↑		
3: 10.5x ↗	Total	452.5
4: 10.4 →		
5: 10.6x ↙		

1: 10.6x ←	Serie	52.9
2: 10.5x ←		
3: 10.5x ↓	Total	505.4
4: 10.9x ↘		
5: 10.4 →		

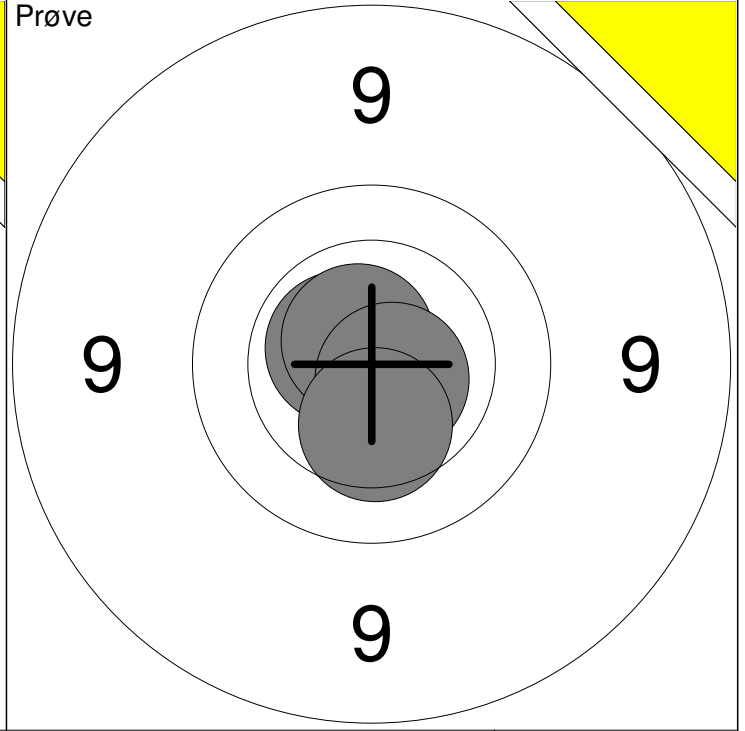
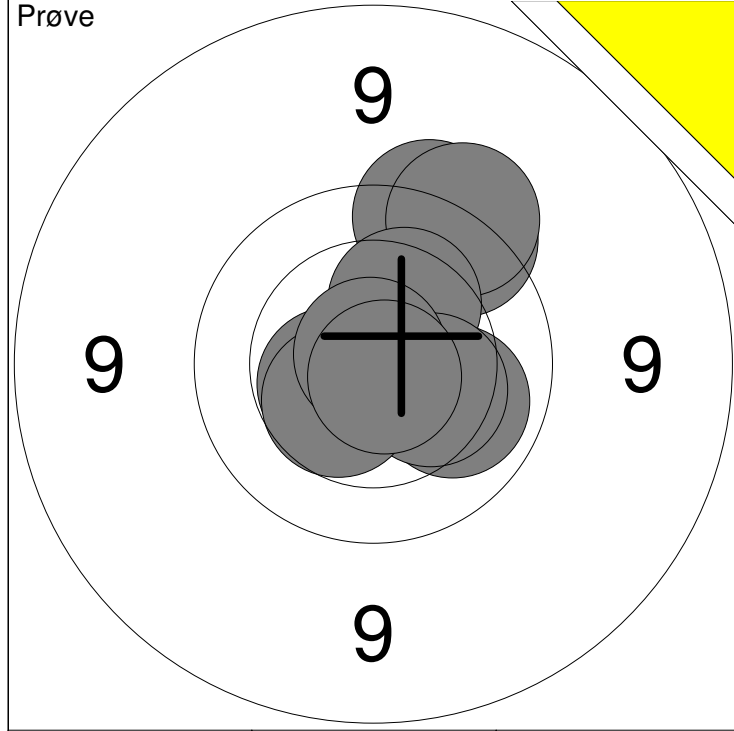

1: 9.7 ↗	6: 10.1 →	Serie	102.3
2: 9.6 ↗	7: 10.3 →		
3: 9.6 ↗	8: 10.5 ↘	Total	400.0
4: 10.3 ↗	9: 10.9x ↗		
5: 10.5x ↙	10: 10.8x ↘		

11: 10.6x ↖	Serie	42.4
12: 10.7x ↗		
13: 10.7x ↘	Total	400.0
14: 10.4 ↓		

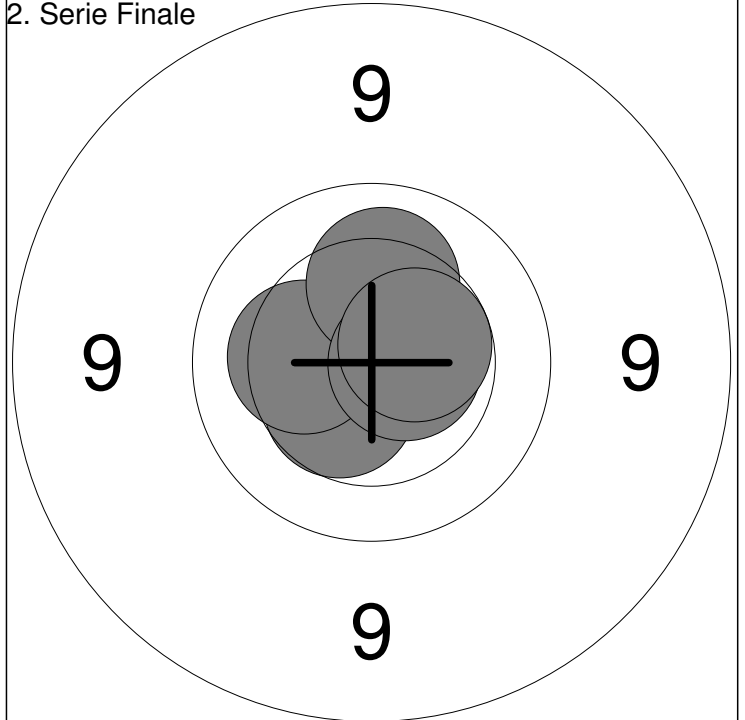
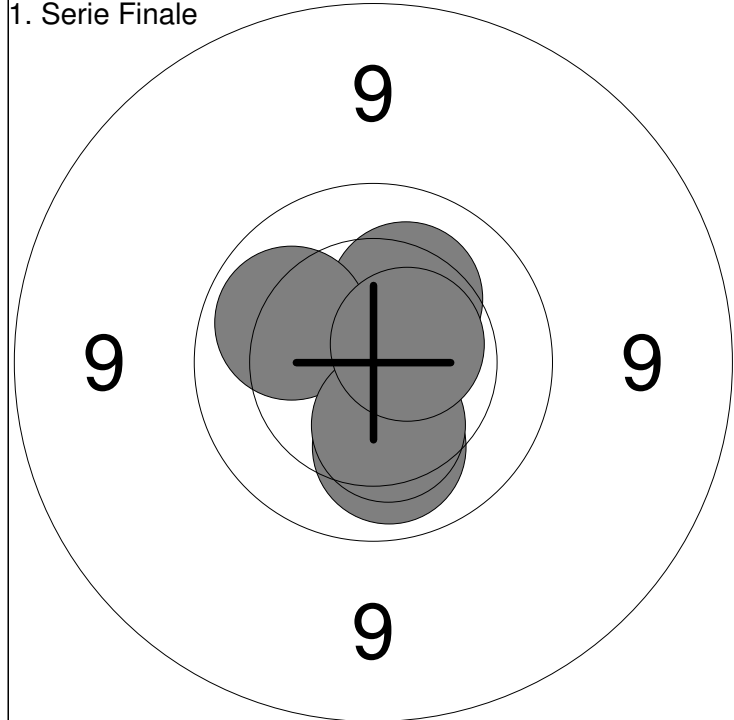

1: 10.3 ↗	Serie	51.4
2: 10.1 ↖		
3: 10.1 ↓	Total	451.4
4: 10.3 ↓		
5: 10.6x ↗		

1: 10.5 ↘	Serie	52.1
2: 10.3 ←		
3: 10.2 ↗	Total	503.5
4: 10.6x →		
5: 10.5x ↗		

Prøve 	1: 10.4 ←
	2: 10.7x ↗
	3: 10.8x ↗
	4: 10.5 ↘
	5: 10.6x ↘
	6: 10.9x ↖
Serie 63.9	
Total 400.0	

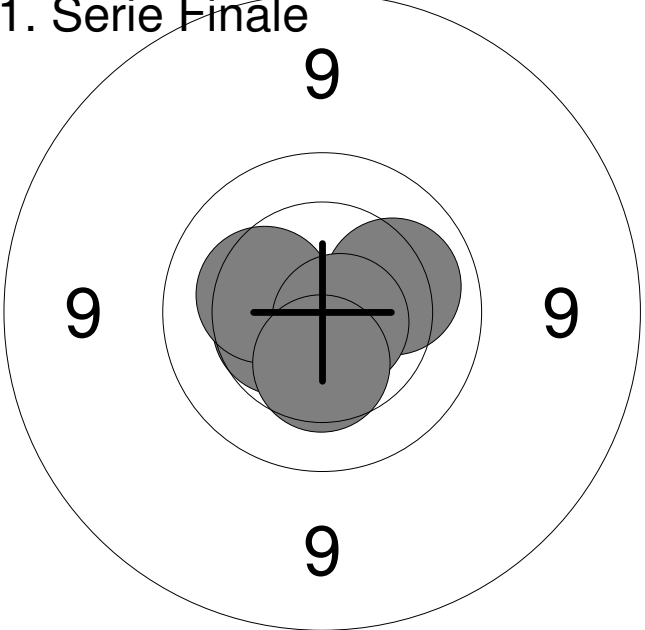
1. Serie Finale 	1: 10.5 ←
	2: 10.1 →
	3: 10.3 ←
	4: 10.7x ↘
	5: 10.4 ↓
Serie 52.0	
Total 452.0	

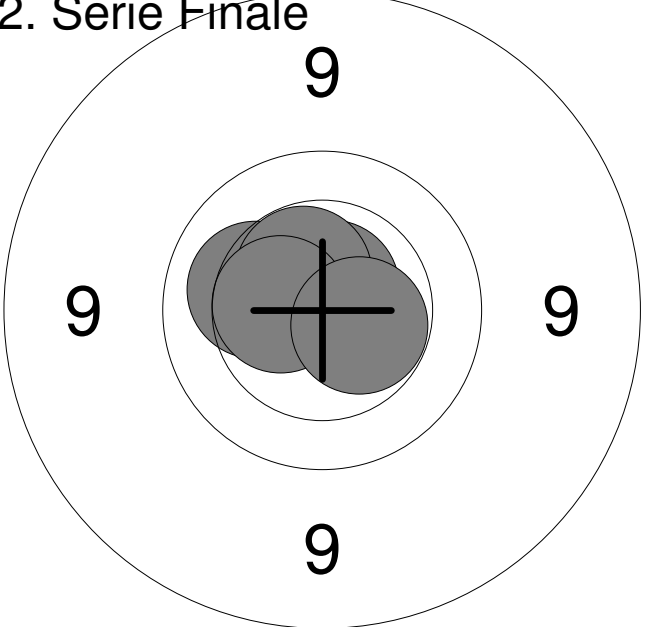
2. Serie Finale 	1: 10.2 ←
	2: 10.7x ↗
	3: 10.5x ↗
	4: 10.5 ←
	5: 10.5x ↘
Serie 52.4	
Total 504.4	

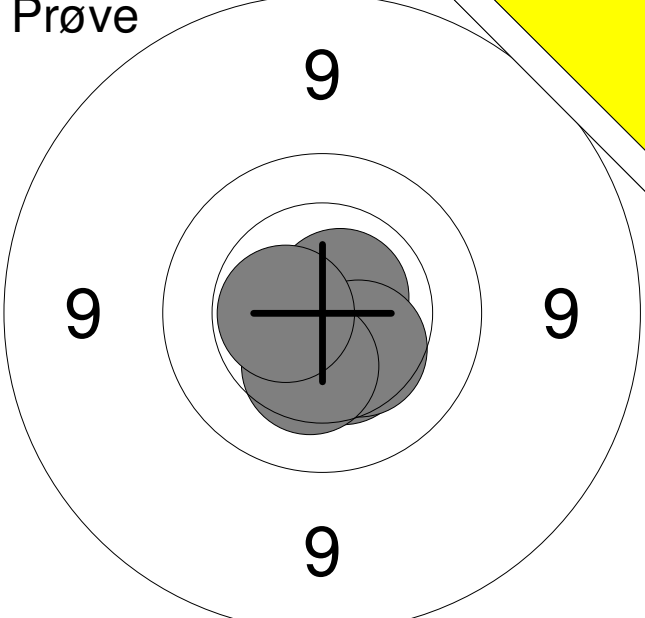
<p>Prøve</p> 	<table style="width:100%; border-collapse: collapse;"> <tr><td style="width:10%;">1:</td><td style="width:20%;">10.4</td><td style="width:10%; text-align: right;">↘</td></tr> <tr><td>2:</td><td>10.7x</td><td style="text-align: right;">↗</td></tr> <tr><td>3:</td><td>10.4</td><td style="text-align: right;">↘</td></tr> <tr><td>4:</td><td>10.3</td><td style="text-align: right;">↘</td></tr> <tr><td>5:</td><td>10.5x</td><td style="text-align: right;">←</td></tr> </table> <table border="1" style="width:100%; border-collapse: collapse; margin-top: 10px;"> <tr> <td style="width:80%;">Serie</td> <td style="text-align: right;">52.3</td> </tr> <tr> <td>Total</td> <td style="text-align: right;">400.0</td> </tr> </table>	1:	10.4	↘	2:	10.7x	↗	3:	10.4	↘	4:	10.3	↘	5:	10.5x	←	Serie	52.3	Total	400.0
1:	10.4	↘																		
2:	10.7x	↗																		
3:	10.4	↘																		
4:	10.3	↘																		
5:	10.5x	←																		
Serie	52.3																			
Total	400.0																			

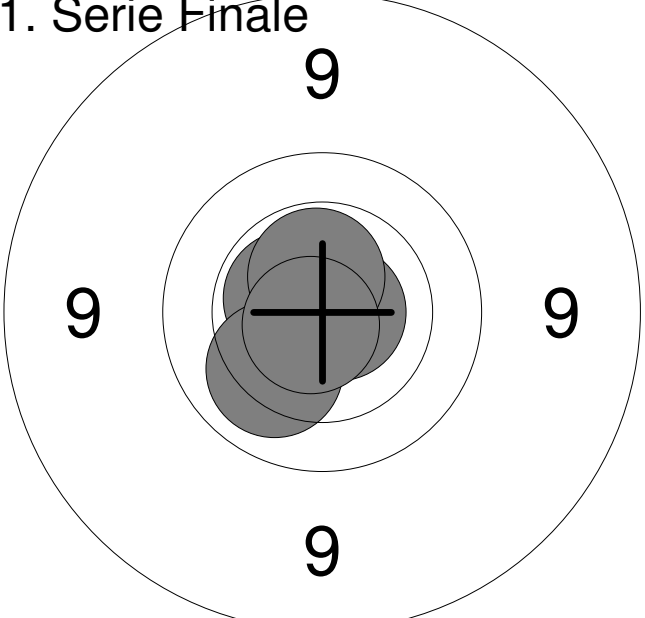
<p>1. Serie Finale</p> 	<table style="width:100%; border-collapse: collapse;"> <tr><td style="width:10%;">1:</td><td style="width:20%;">10.6x</td><td style="width:10%; text-align: right;">↖</td></tr> <tr><td>2:</td><td>10.1</td><td style="text-align: right;">↘</td></tr> <tr><td>3:</td><td>10.8x</td><td style="text-align: right;">→</td></tr> <tr><td>4:</td><td>10.6x</td><td style="text-align: right;">↑</td></tr> <tr><td>5:</td><td>10.8x</td><td style="text-align: right;">↙</td></tr> </table> <table border="1" style="width:100%; border-collapse: collapse; margin-top: 10px;"> <tr> <td style="width:80%;">Serie</td> <td style="text-align: right;">52.9</td> </tr> <tr> <td>Total</td> <td style="text-align: right;">452.9</td> </tr> </table>	1:	10.6x	↖	2:	10.1	↘	3:	10.8x	→	4:	10.6x	↑	5:	10.8x	↙	Serie	52.9	Total	452.9
1:	10.6x	↖																		
2:	10.1	↘																		
3:	10.8x	→																		
4:	10.6x	↑																		
5:	10.8x	↙																		
Serie	52.9																			
Total	452.9																			

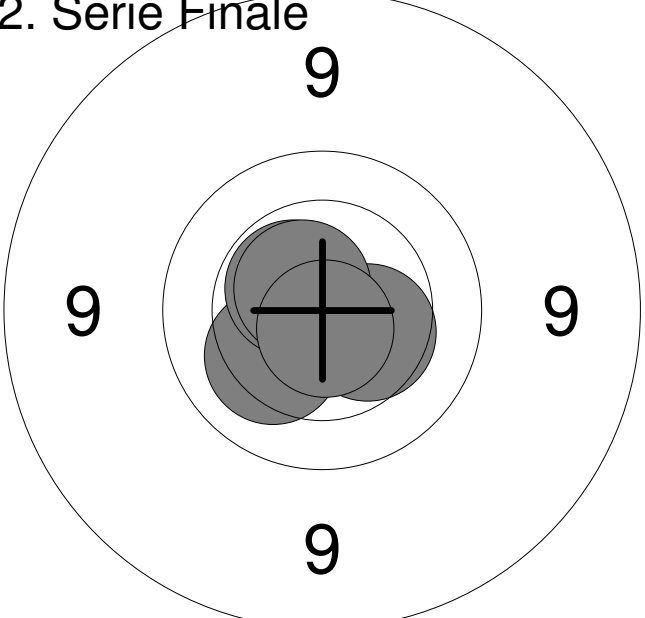
<p>2. Serie Finale</p> 	<table style="width:100%; border-collapse: collapse;"> <tr><td style="width:10%;">1:</td><td style="width:20%;">10.4</td><td style="width:10%; text-align: right;">↘</td></tr> <tr><td>2:</td><td>10.2</td><td style="text-align: right;">↘</td></tr> <tr><td>3:</td><td>10.5x</td><td style="text-align: right;">↗</td></tr> <tr><td>4:</td><td>10.6x</td><td style="text-align: right;">↗</td></tr> <tr><td>5:</td><td>10.7x</td><td style="text-align: right;">↘</td></tr> </table> <table border="1" style="width:100%; border-collapse: collapse; margin-top: 10px;"> <tr> <td style="width:80%;">Serie</td> <td style="text-align: right;">52.4</td> </tr> <tr> <td>Total</td> <td style="text-align: right;">505.3</td> </tr> </table>	1:	10.4	↘	2:	10.2	↘	3:	10.5x	↗	4:	10.6x	↗	5:	10.7x	↘	Serie	52.4	Total	505.3
1:	10.4	↘																		
2:	10.2	↘																		
3:	10.5x	↗																		
4:	10.6x	↗																		
5:	10.7x	↘																		
Serie	52.4																			
Total	505.3																			

Hold 1	Skive 9	Hana Poskovic	
------------------	-------------------	----------------------	--

Aalborg	Løgstør Sportsskytteklub	BK	S
---------	--------------------------	----	---

02.03.2018	Nordjysk mesterskab Finaler	Aalborg Skyttekreds	
------------	-----------------------------	---------------------	--

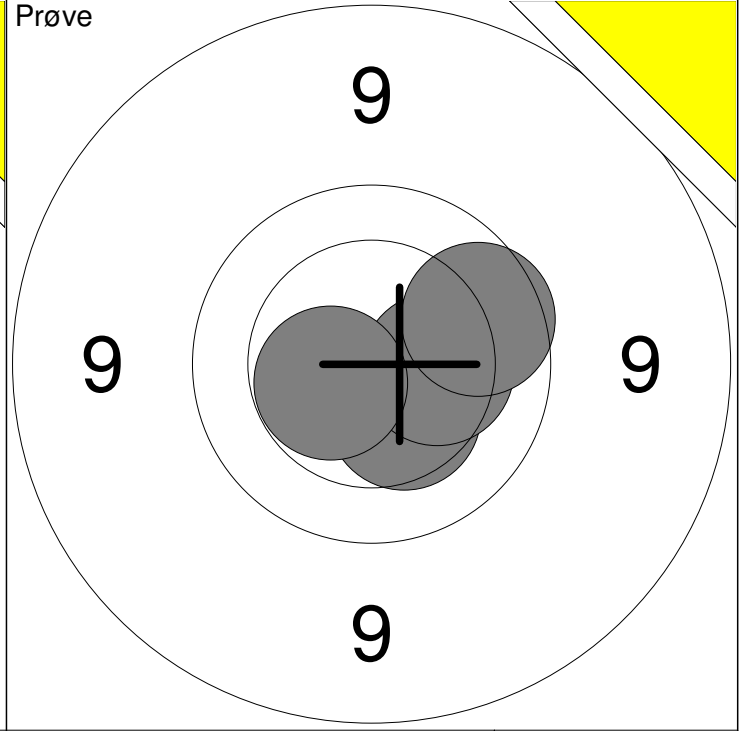
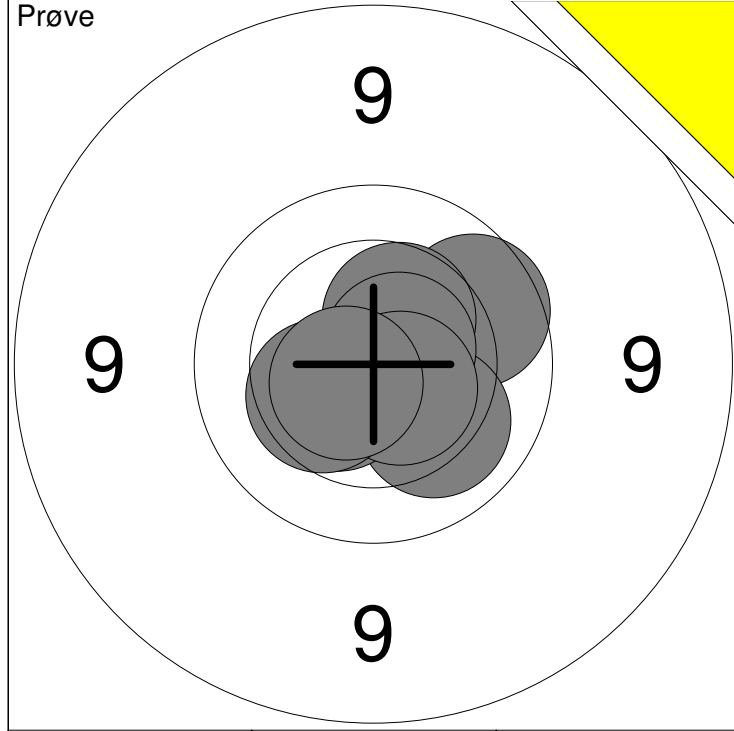

1: 10.5x →	6: 10.5 ↙	Serie	104.4
2: 9.9 ↗	7: 10.7x ↗		
3: 10.1 ↘	8: 10.6x ↘	Total	400.0
4: 10.7x ↙	9: 10.4 ↙		
5: 10.4 ↗	10: 10.6x ↙		

11: 10.4 ↘	Serie	41.1
12: 10.3 →		
13: 9.9 ↗	Total	400.0
14: 10.5x ↙		

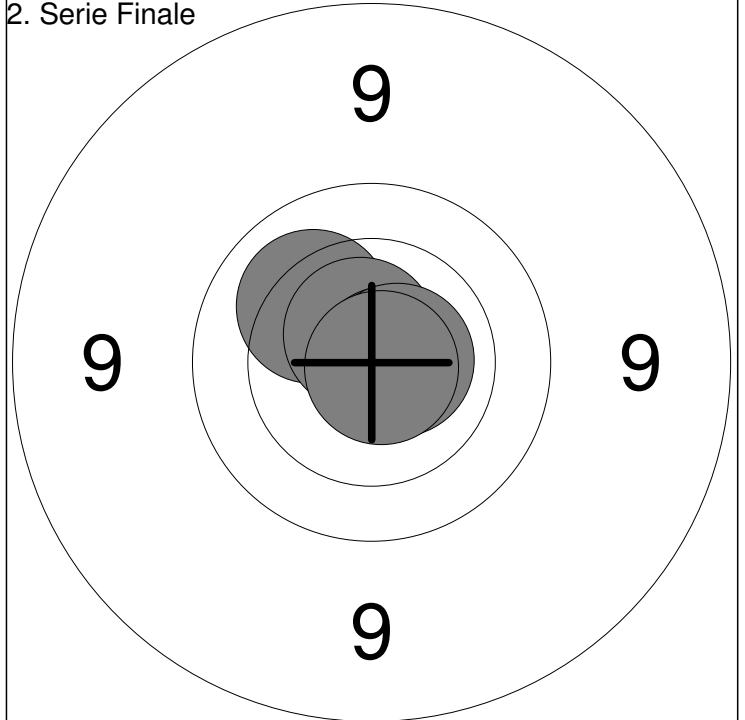
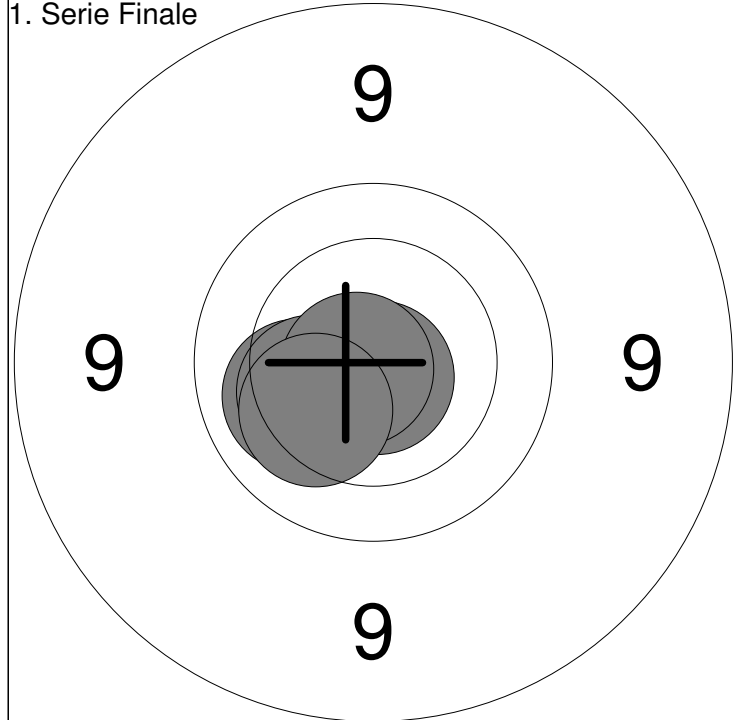

1: 10.2 ↙	Serie	52.3
2: 10.8x ↘		
3: 10.3 ↙	Total	452.3
4: 10.8x ↙		
5: 10.2 ↙		

1: 10.2 ↗	Serie	53.2
2: 10.7x ↗		
3: 10.8x →	Total	505.5
4: 10.7x →		
5: 10.8x ↘		

Hold 1	Skive 10	Cammilla Johannesen																																
Aalborg		Boddum-Ydby Skytteforening		BK																														
02.03.2018		Nordjysk mesterskab Finaler		Aalborg Skyttekreds																														
Prøve		<table border="0"> <tr><td>1:</td><td>10.4</td><td>→</td></tr> <tr><td>2:</td><td>10.2</td><td>↓</td></tr> <tr><td>3:</td><td>9.9</td><td>↘</td></tr> <tr><td>4:</td><td>10.6x</td><td>←</td></tr> <tr><td>5:</td><td>10.4</td><td>↘</td></tr> <tr><td>6:</td><td>10.4</td><td>↗</td></tr> <tr><td>7:</td><td>10.6x</td><td>↓</td></tr> <tr><td>8:</td><td>10.2</td><td>←</td></tr> <tr><td>9:</td><td>10.1</td><td>↘</td></tr> <tr><td>10:</td><td>10.3</td><td>↓</td></tr> </table>			1:	10.4	→	2:	10.2	↓	3:	9.9	↘	4:	10.6x	←	5:	10.4	↘	6:	10.4	↗	7:	10.6x	↓	8:	10.2	←	9:	10.1	↘	10:	10.3	↓
1:	10.4	→																																
2:	10.2	↓																																
3:	9.9	↘																																
4:	10.6x	←																																
5:	10.4	↘																																
6:	10.4	↗																																
7:	10.6x	↓																																
8:	10.2	←																																
9:	10.1	↘																																
10:	10.3	↓																																
		Serie 103.1																																
		Total 400.0																																
1. Serie Finale		<table border="0"> <tr><td>1:</td><td>10.5</td><td>↓</td></tr> <tr><td>2:</td><td>10.6x</td><td>↓</td></tr> <tr><td>3:</td><td>10.3</td><td>←</td></tr> <tr><td>4:</td><td>10.3</td><td>→</td></tr> <tr><td>5:</td><td>10.4</td><td>↘</td></tr> </table>			1:	10.5	↓	2:	10.6x	↓	3:	10.3	←	4:	10.3	→	5:	10.4	↘															
1:	10.5	↓																																
2:	10.6x	↓																																
3:	10.3	←																																
4:	10.3	→																																
5:	10.4	↘																																
		Serie 52.1																																
		Total 452.1																																
2. Serie Finale		<table border="0"> <tr><td>1:</td><td>10.3</td><td>→</td></tr> <tr><td>2:</td><td>10.1</td><td>↘</td></tr> <tr><td>3:</td><td>10.8x</td><td>↘</td></tr> <tr><td>4:</td><td>10.4</td><td>→</td></tr> <tr><td>5:</td><td>10.3</td><td>↘</td></tr> </table>			1:	10.3	→	2:	10.1	↘	3:	10.8x	↘	4:	10.4	→	5:	10.3	↘															
1:	10.3	→																																
2:	10.1	↘																																
3:	10.8x	↘																																
4:	10.4	→																																
5:	10.3	↘																																
		Serie 51.9																																
		Total 504.0																																

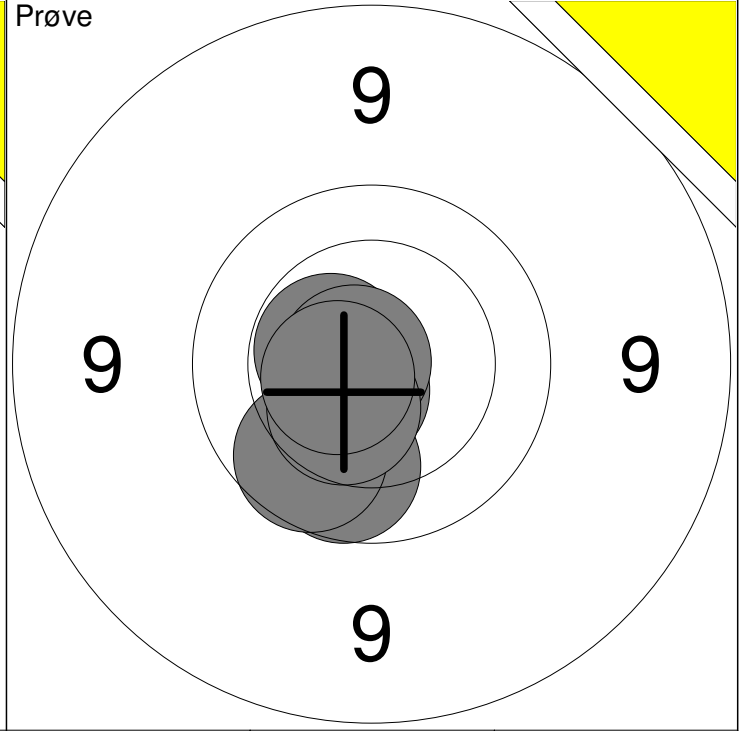
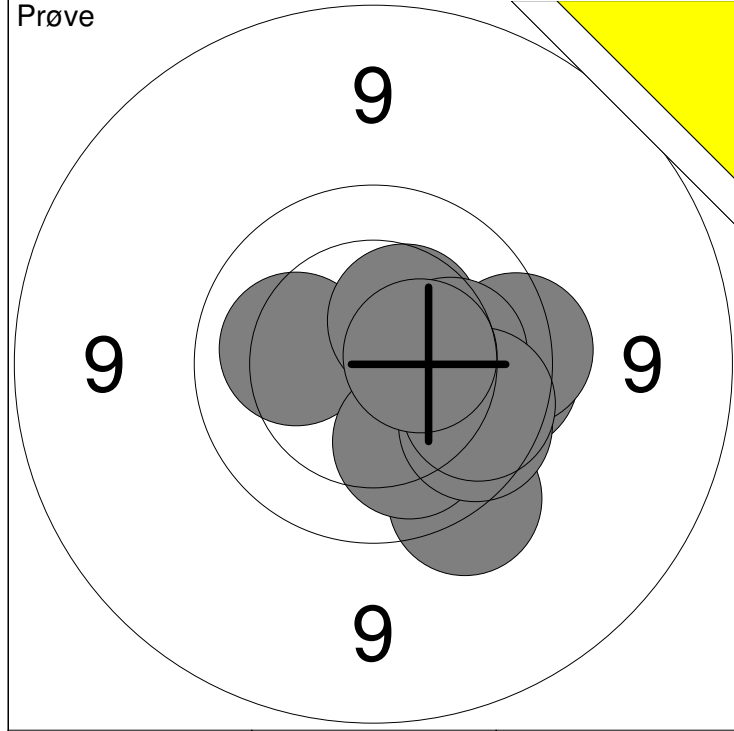

1: 10.2 ←	6: 10.1 ↓	Serie	100.3
2: 9.6 ↓	7: 9.9 ↓		
3: 9.8 →	8: 10.2 →	Total	400.0
4: 9.7 →	9: 9.9 →		
5: 10.4 ↗	10: 10.5 →		

11: 9.9 ↓	16: 10.4 ↓	Serie	72.7
12: 10.6x ↓	17: 10.6x ←		
13: 10.5x ←		Total	400.0
14: 10.8x ←			
15: 9.9 ↓			

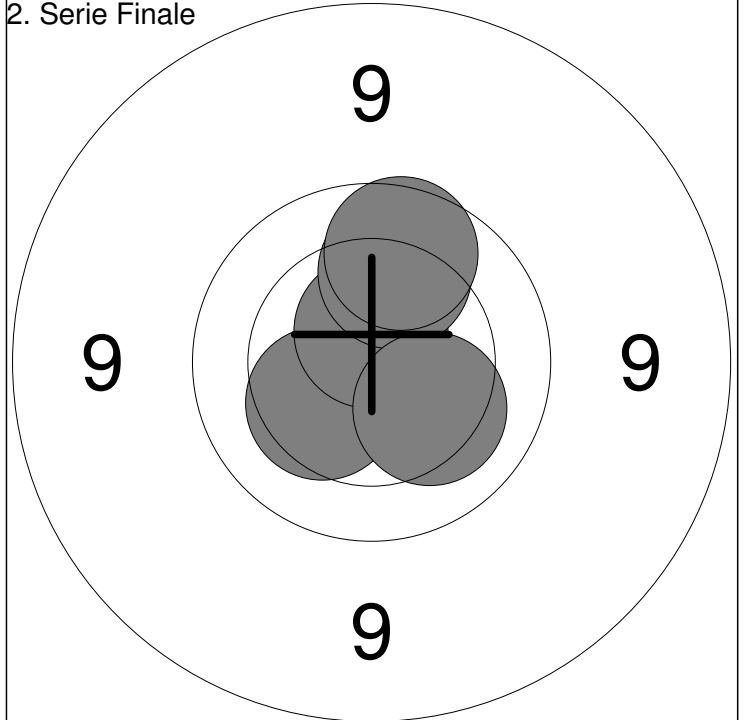
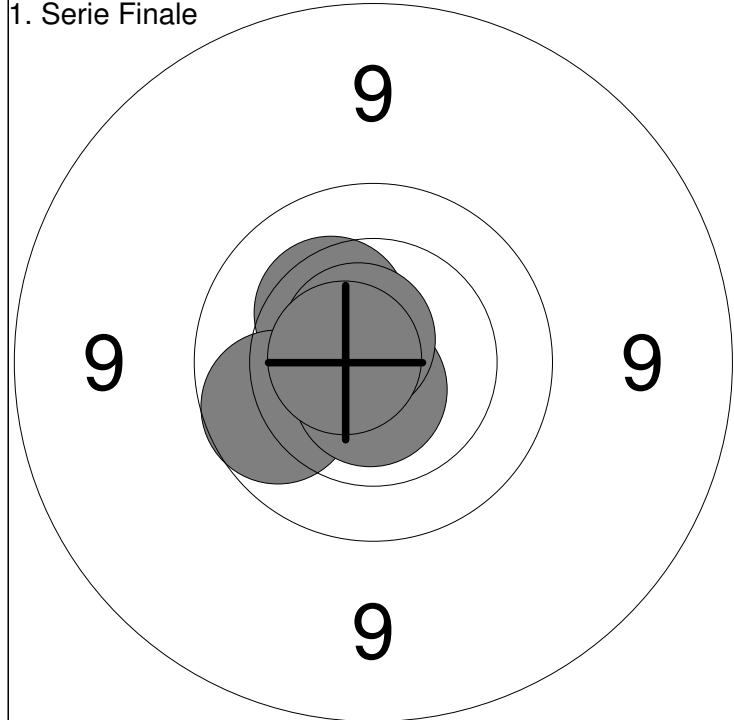

1: 10.3 ↗	Serie	52.3
2: 9.9 ←		
3: 10.7x ↓	Total	452.3
4: 10.7x ↗		
5: 10.7x ←		

1: 10.3 ←	Serie	51.0
2: 10.6x ↑		
3: 10.0 ↑	Total	503.3
4: 9.9 ↑		
5: 10.2 ↓		

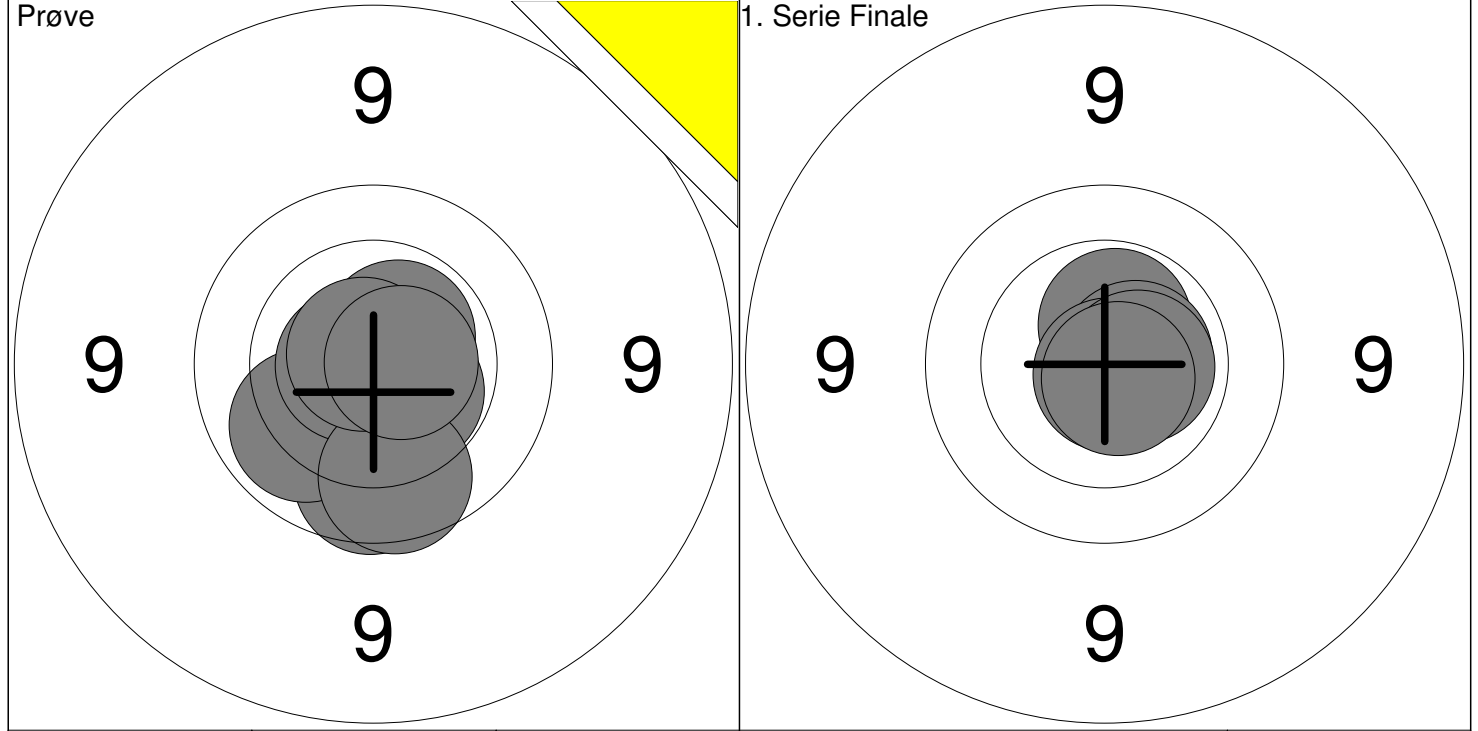

1: 10.5x ↘	6: 9.9 ↓	Serie	83.2	1: 10.6x ↑	Serie	53.4
2: 9.9 ↓	7: 10.8x ↙			2: 10.6x →		
3: 10.1 ↙	8: 10.7x →	Total	400.0	3: 10.8x ↓	Total	453.4
4: 10.7x ←				4: 10.6x →		
5: 10.6x ↗				5: 10.8x ↓		

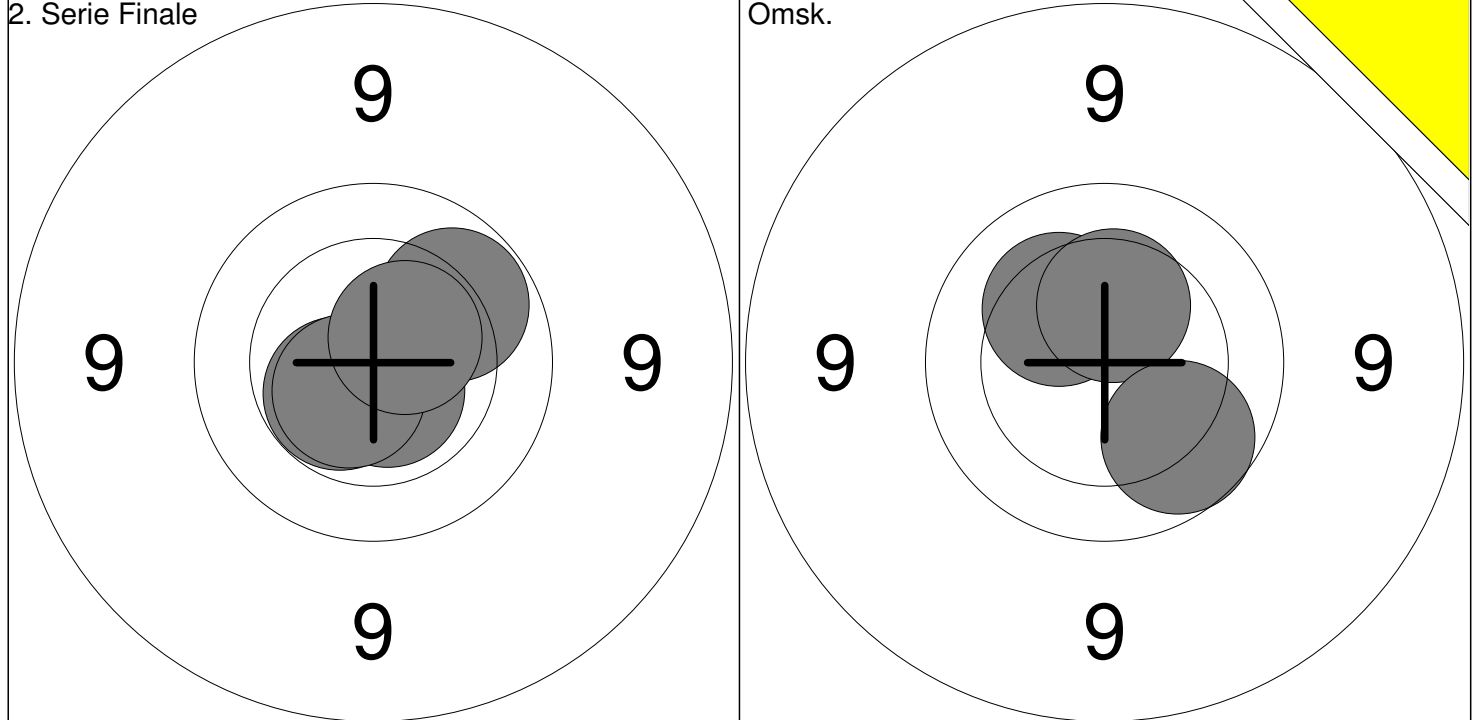

1: 10.5x ↙	Serie	52.3	1: 10.3 ↗	Serie	30.6
2: 10.6x ↓			2: 10.4 ↑		
3: 10.0 ↗	Total	505.7	3: 9.9 ↓	Total	505.7
4: 10.6x ↙					
5: 10.6x ↗					

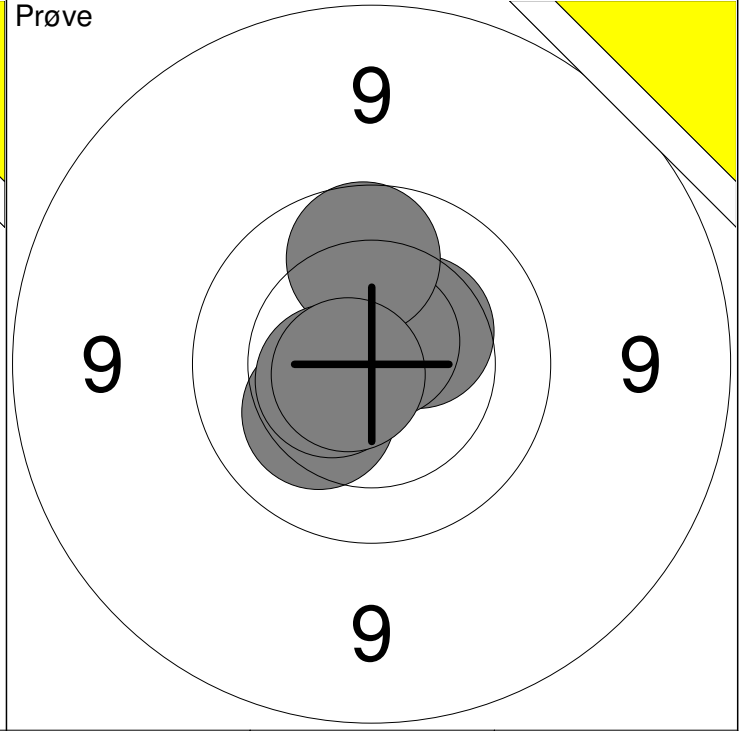
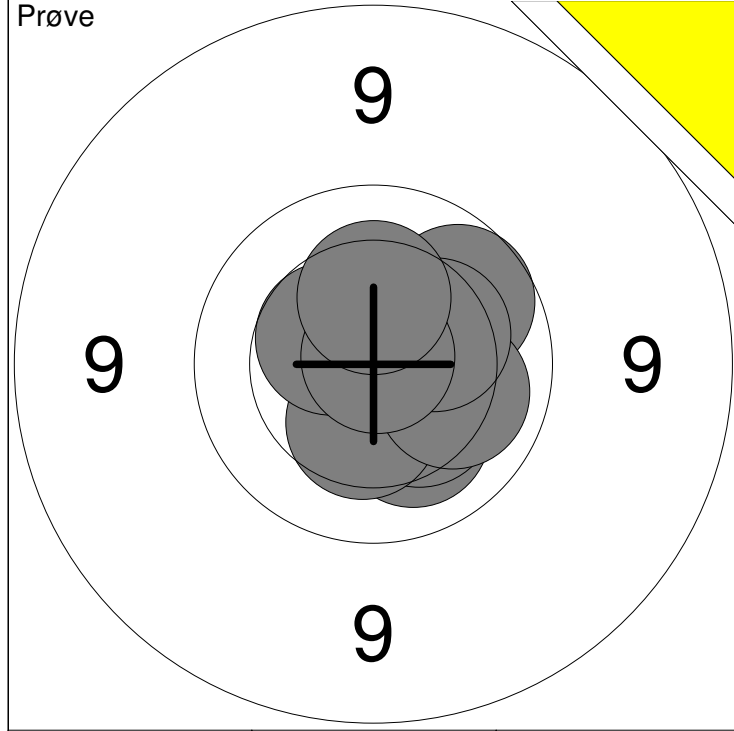

1: 10.2 ↘	6: 10.6x ↗	Serie 103.5
2: 10.3 ↘	7: 10.3 →	
3: 9.9 ↗	8: 10.5 ↖	Total 400.0
4: 10.4 ↘	9: 10.9x ↗	
5: 10.1 →	10: 10.3 ↗	

11: 10.4 ↗	16: 10.7x ↖	Serie 62.4
12: 10.2 ↘	13: 10.7x ↗	
14: 9.9 ↗	15: 10.5x ↖	Total 400.0

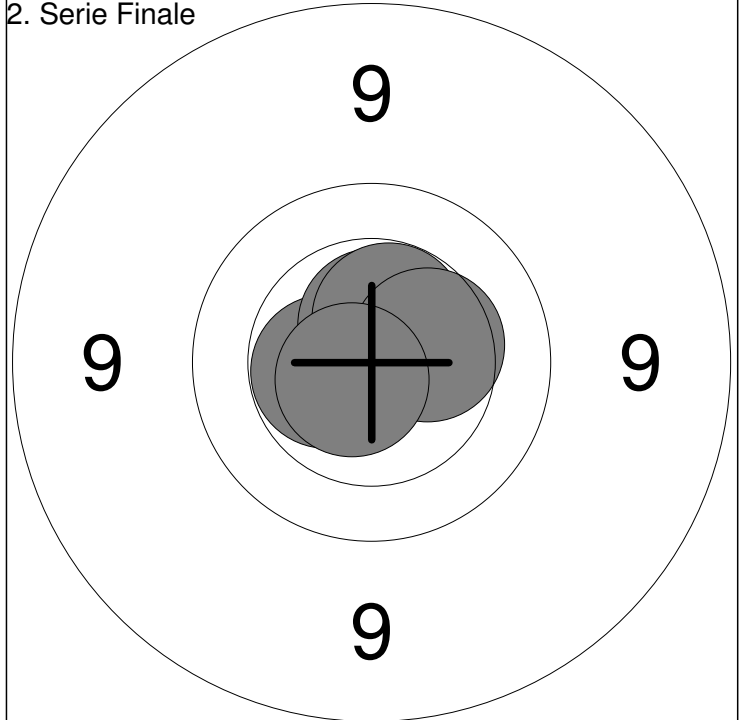
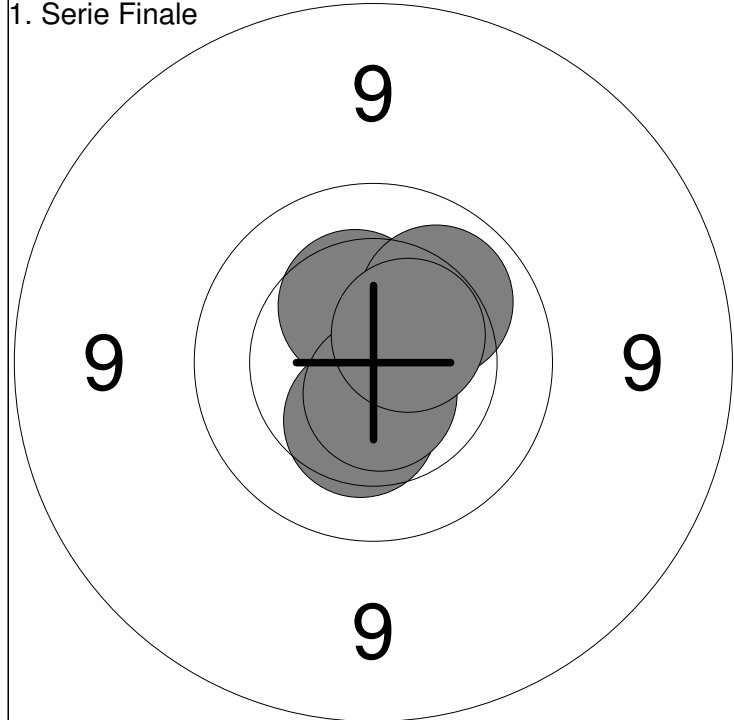

1: 10.4 ↗	Serie 52.0
2: 10.1 ↗	
3: 10.4 ↘	Total 452.0
4: 10.6x ↘	
5: 10.5x ↗	

1: 10.5x ↖	Serie 52.7
2: 10.6x ↗	
3: 10.5x ↗	Total 504.7
4: 10.4 →	
5: 10.7x ↖	

<p>Prøve</p>	<table style="width:100%; border-collapse: collapse;"> <tr><td style="width:10%;">1:</td><td style="width:80%;">10.0</td><td style="width:10%; text-align: right;">↘</td></tr> <tr><td>2:</td><td>10.6x</td><td style="text-align: right;">↗</td></tr> <tr><td>3:</td><td>10.5x</td><td style="text-align: right;">↗</td></tr> <tr><td>4:</td><td>10.5</td><td style="text-align: right;">↗</td></tr> <tr><td>5:</td><td>10.3</td><td style="text-align: right;">↗</td></tr> <tr><td>6:</td><td>10.9x</td><td style="text-align: right;">↘</td></tr> </table>	1:	10.0	↘	2:	10.6x	↗	3:	10.5x	↗	4:	10.5	↗	5:	10.3	↗	6:	10.9x	↘
1:	10.0	↘																	
2:	10.6x	↗																	
3:	10.5x	↗																	
4:	10.5	↗																	
5:	10.3	↗																	
6:	10.9x	↘																	
<table style="width:100%; border-collapse: collapse;"> <tr> <td style="width:80%;">Serie</td> <td style="text-align: right;">62.8</td> </tr> <tr> <td>Total</td> <td style="text-align: right;">400.0</td> </tr> </table>		Serie	62.8	Total	400.0														
Serie	62.8																		
Total	400.0																		

<p>1. Serie Finale</p>	<table style="width:100%; border-collapse: collapse;"> <tr><td style="width:10%;">1:</td><td style="width:80%;">10.5x</td><td style="width:10%; text-align: right;">↓</td></tr> <tr><td>2:</td><td>10.1</td><td style="text-align: right;">↓</td></tr> <tr><td>3:</td><td>10.6x</td><td style="text-align: right;">↗</td></tr> <tr><td>4:</td><td>10.6x</td><td style="text-align: right;">↗</td></tr> <tr><td>5:</td><td>10.8x</td><td style="text-align: right;">→</td></tr> </table>	1:	10.5x	↓	2:	10.1	↓	3:	10.6x	↗	4:	10.6x	↗	5:	10.8x	→
1:	10.5x	↓														
2:	10.1	↓														
3:	10.6x	↗														
4:	10.6x	↗														
5:	10.8x	→														
<table style="width:100%; border-collapse: collapse;"> <tr> <td style="width:80%;">Serie</td> <td style="text-align: right;">52.6</td> </tr> <tr> <td>Total</td> <td style="text-align: right;">452.6</td> </tr> </table>		Serie	52.6	Total	452.6											
Serie	52.6															
Total	452.6															

<p>2. Serie Finale</p>	<table style="width:100%; border-collapse: collapse;"> <tr><td style="width:10%;">1:</td><td style="width:80%;">9.9</td><td style="width:10%; text-align: right;">↗</td></tr> <tr><td>2:</td><td>10.3</td><td style="text-align: right;">↗</td></tr> <tr><td>3:</td><td>10.6x</td><td style="text-align: right;">↗</td></tr> <tr><td>4:</td><td>10.3</td><td style="text-align: right;">→</td></tr> <tr><td>5:</td><td>10.5</td><td style="text-align: right;">↖</td></tr> </table>	1:	9.9	↗	2:	10.3	↗	3:	10.6x	↗	4:	10.3	→	5:	10.5	↖
1:	9.9	↗														
2:	10.3	↗														
3:	10.6x	↗														
4:	10.3	→														
5:	10.5	↖														
<table style="width:100%; border-collapse: collapse;"> <tr> <td style="width:80%;">Serie</td> <td style="text-align: right;">51.6</td> </tr> <tr> <td>Total</td> <td style="text-align: right;">504.2</td> </tr> </table>		Serie	51.6	Total	504.2											
Serie	51.6															
Total	504.2															

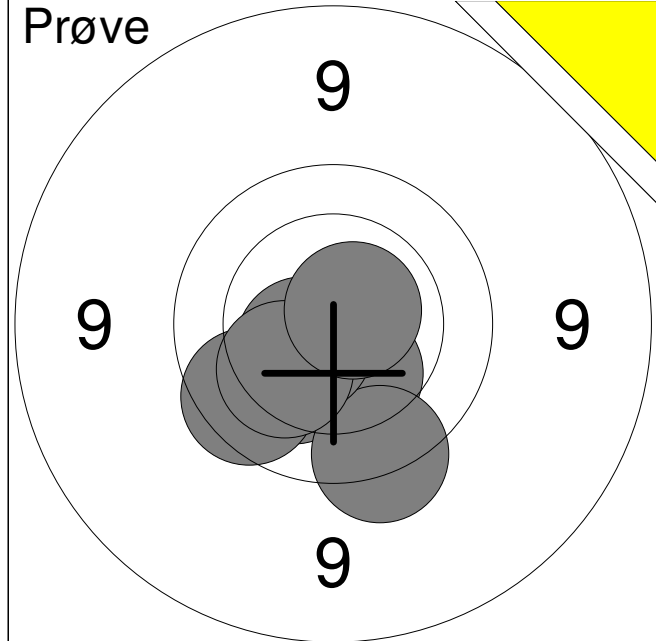

1:	10.2	↙
2:	9.8	↙
3:	10.4	↘
4:	9.7	↘
5:	10.6x	↙
6:	10.2	↙
7:	10.7x	↗
Serie		71.6
Total		399.0

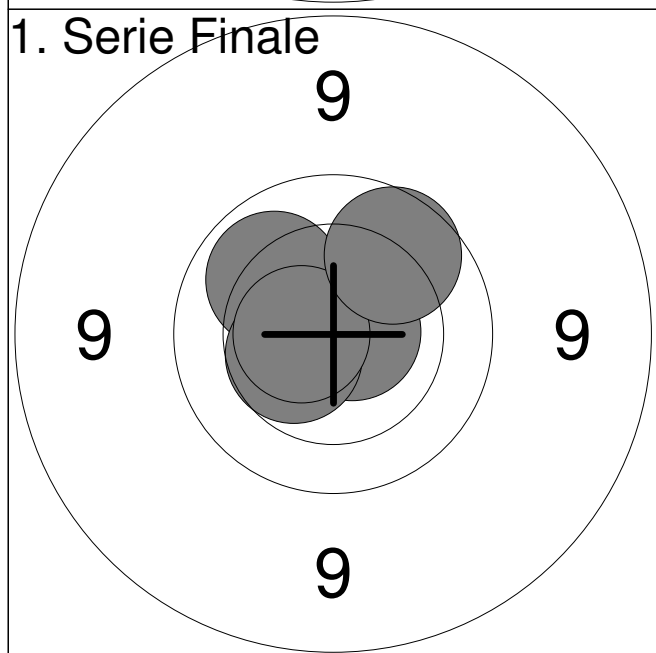

1:	10.7x	→
2:	10.1	↖
3:	10.5	↙
4:	10.6x	←
5:	9.9	↗
Serie		51.8
Total		450.8

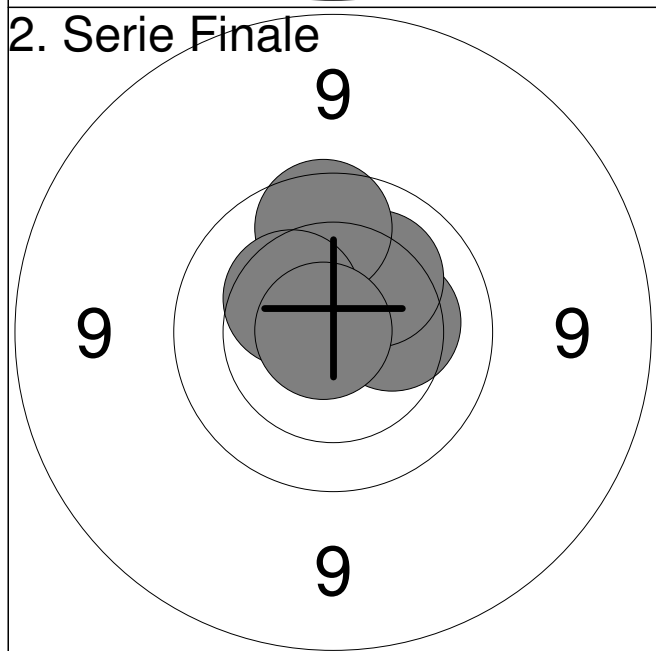

1:	10.3	→
2:	10.2	↗
3:	9.9	↑
4:	10.4	↖
5:	10.8x	←
Serie		51.6
Total		502.4

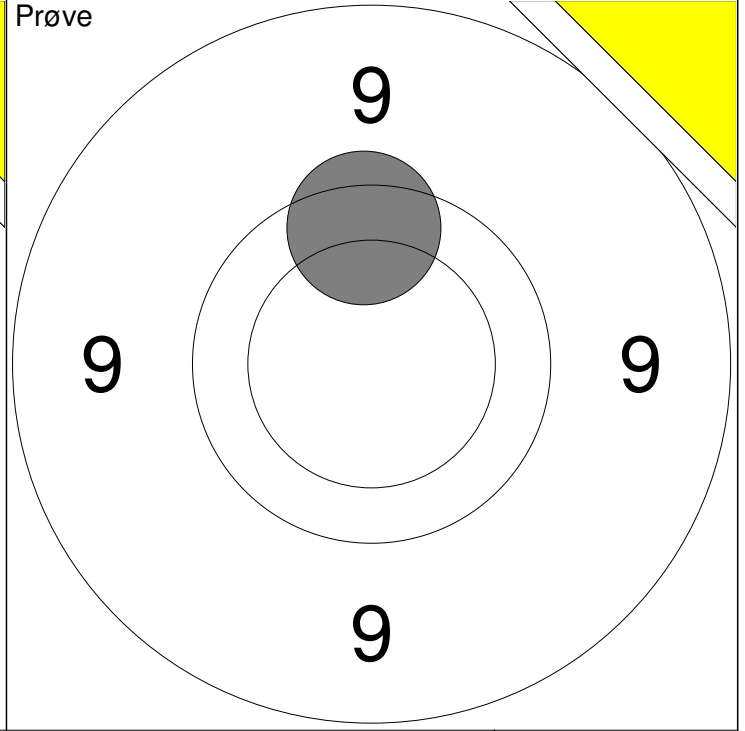
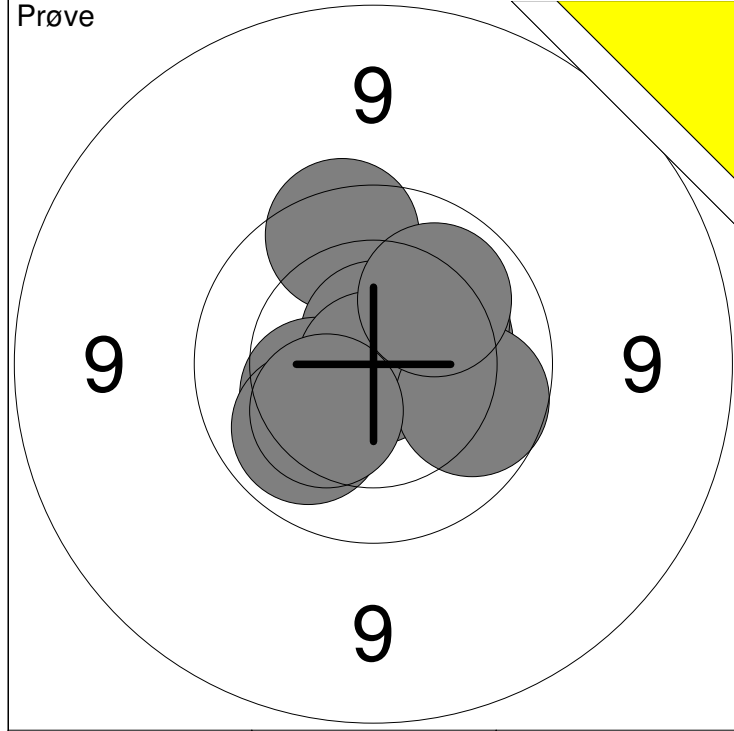

1: 10.3 →	6: 10.9x ↓	Serie 102.6
2: 9.8 ↑	7: 10.1 ↙	
3: 10.7x ↑	8: 9.9 →	Total 399.0
4: 10.2 ↗	9: 10.3 ↙	
5: 10.3 ↙	10: 10.1 ↗	

11: 9.8 ↑	Serie 9.8
	Total 399.0

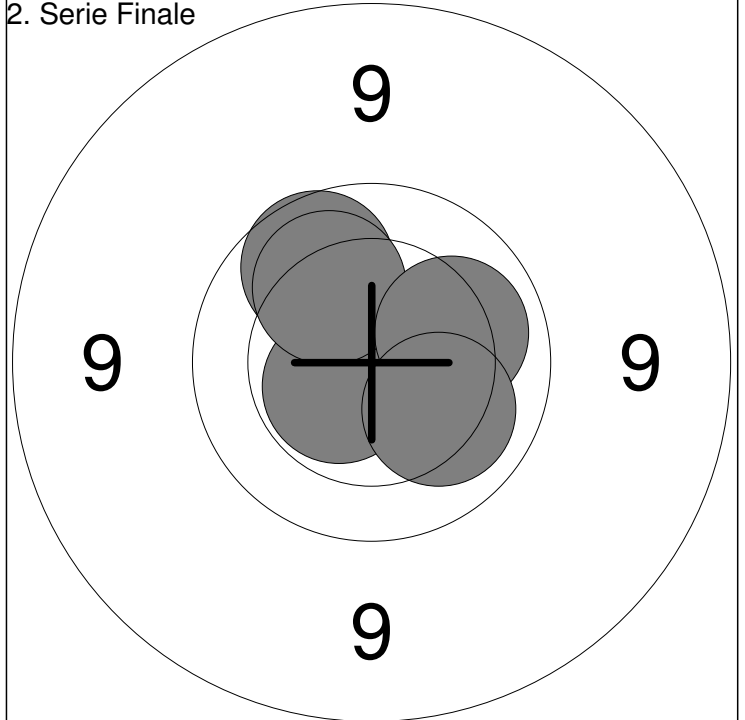
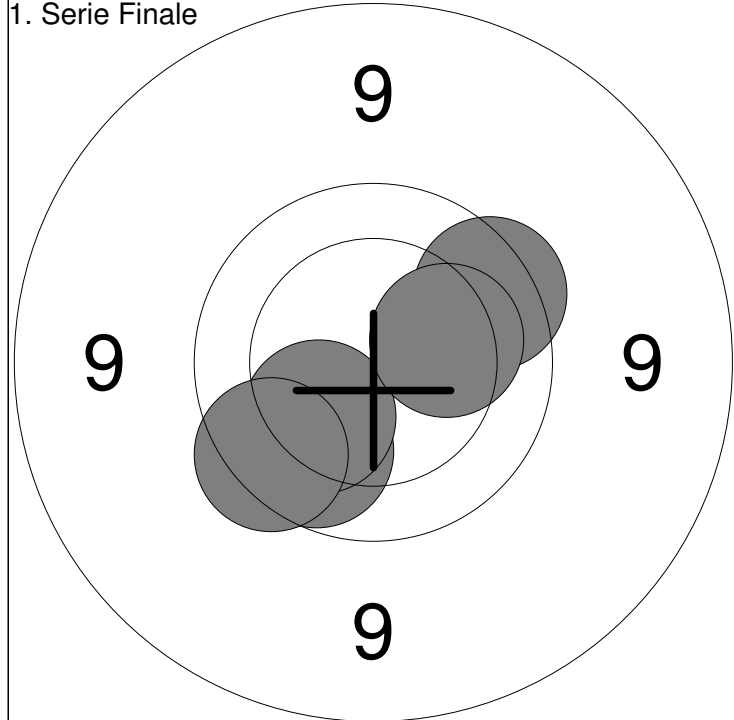

1: 9.9 ↙	Serie 49.9
2: 10.2 ↙	
3: 9.8 ↙	Total 448.9
4: 9.8 ↗	
5: 10.2 →	

1: 9.9 ↗	Serie 50.8
2: 10.6x ↙	
3: 10.1 ↗	Total 499.7
4: 10.1 →	
5: 10.1 ↘	

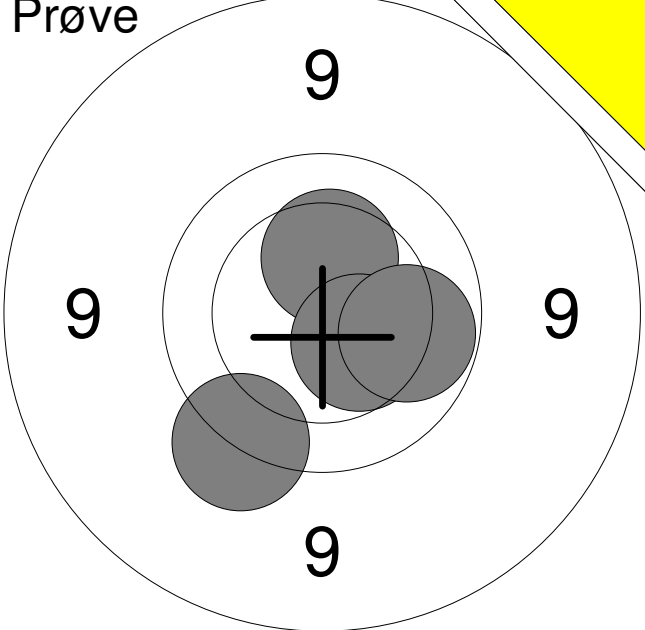
Prøve 	1: 9.6 ↘
	2: 10.3 ↑
	3: 10.4 ↘
	4: 10.0 →
Serie 40.3	
Total 399.0	

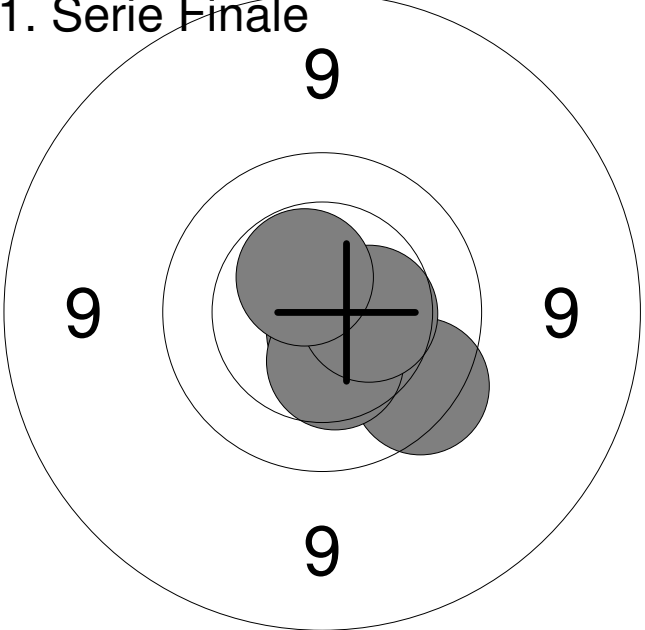
1. Serie Finale 	1: 9.7 ↘
	2: 10.7x ↘
	3: 10.4 ↘
	4: 10.4 →
	5: 10.5x ↗
Serie 51.7	
Total 450.7	

2. Serie Finale 	1: 10.3 ↘
	2: 10.7x ↑
	3: 10.0 ↘
	4: 10.3 →
	5: 9.9 ↗
Serie 51.2	
Total 501.9	

<p>Prøve</p>	<table style="width:100%; border-collapse: collapse;"> <tr><td style="width:10%;">1:</td><td style="width:80%;">9.4</td><td style="width:10%; text-align: right;">←</td></tr> <tr><td>2:</td><td>10.4</td><td style="text-align: right;">↖</td></tr> <tr><td>3:</td><td>10.1</td><td style="text-align: right;">↗</td></tr> <tr><td>4:</td><td>10.6x</td><td style="text-align: right;">→</td></tr> <tr><td>5:</td><td>9.9</td><td style="text-align: right;">↑</td></tr> <tr><td>6:</td><td>10.6x</td><td style="text-align: right;">↗</td></tr> <tr><td>7:</td><td>10.7x</td><td style="text-align: right;">↓</td></tr> <tr><td>8:</td><td>10.1</td><td style="text-align: right;">↖</td></tr> <tr><td>9:</td><td>10.3</td><td style="text-align: right;">↗</td></tr> </table> <table border="1" style="width:100%; border-collapse: collapse; margin-top: 5px;"> <tr> <td style="width:90%;">Serie</td> <td style="width:10%; text-align: right;">92.1</td> </tr> <tr> <td>Total</td> <td style="text-align: right;">398.0</td> </tr> </table>	1:	9.4	←	2:	10.4	↖	3:	10.1	↗	4:	10.6x	→	5:	9.9	↑	6:	10.6x	↗	7:	10.7x	↓	8:	10.1	↖	9:	10.3	↗	Serie	92.1	Total	398.0
1:	9.4	←																														
2:	10.4	↖																														
3:	10.1	↗																														
4:	10.6x	→																														
5:	9.9	↑																														
6:	10.6x	↗																														
7:	10.7x	↓																														
8:	10.1	↖																														
9:	10.3	↗																														
Serie	92.1																															
Total	398.0																															

<p>1. Serie Finale</p>	<table style="width:100%; border-collapse: collapse;"> <tr><td style="width:10%;">1:</td><td style="width:80%;">9.7</td><td style="width:10%; text-align: right;">→</td></tr> <tr><td>2:</td><td>9.9</td><td style="text-align: right;">↑</td></tr> <tr><td>3:</td><td>10.1</td><td style="text-align: right;">←</td></tr> <tr><td>4:</td><td>10.8x</td><td style="text-align: right;">←</td></tr> <tr><td>5:</td><td>10.0</td><td style="text-align: right;">→</td></tr> </table> <table border="1" style="width:100%; border-collapse: collapse; margin-top: 5px;"> <tr> <td style="width:90%;">Serie</td> <td style="width:10%; text-align: right;">50.5</td> </tr> <tr> <td>Total</td> <td style="text-align: right;">448.5</td> </tr> </table>	1:	9.7	→	2:	9.9	↑	3:	10.1	←	4:	10.8x	←	5:	10.0	→	Serie	50.5	Total	448.5
1:	9.7	→																		
2:	9.9	↑																		
3:	10.1	←																		
4:	10.8x	←																		
5:	10.0	→																		
Serie	50.5																			
Total	448.5																			

<p>2. Serie Finale</p>	<table style="width:100%; border-collapse: collapse;"> <tr><td style="width:10%;">1:</td><td style="width:80%;">10.5x</td><td style="width:10%; text-align: right;">↖</td></tr> <tr><td>2:</td><td>10.3</td><td style="text-align: right;">↑</td></tr> <tr><td>3:</td><td>10.3</td><td style="text-align: right;">↓</td></tr> <tr><td>4:</td><td>10.3</td><td style="text-align: right;">→</td></tr> <tr><td>5:</td><td>10.8x</td><td style="text-align: right;">↖</td></tr> </table> <table border="1" style="width:100%; border-collapse: collapse; margin-top: 5px;"> <tr> <td style="width:90%;">Serie</td> <td style="width:10%; text-align: right;">52.2</td> </tr> <tr> <td>Total</td> <td style="text-align: right;">500.7</td> </tr> </table>	1:	10.5x	↖	2:	10.3	↑	3:	10.3	↓	4:	10.3	→	5:	10.8x	↖	Serie	52.2	Total	500.7
1:	10.5x	↖																		
2:	10.3	↑																		
3:	10.3	↓																		
4:	10.3	→																		
5:	10.8x	↖																		
Serie	52.2																			
Total	500.7																			

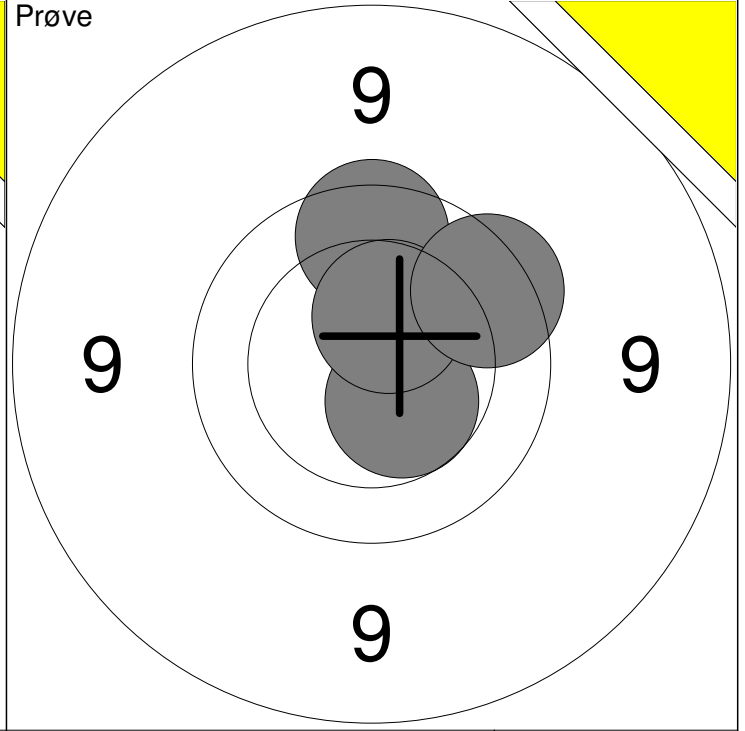
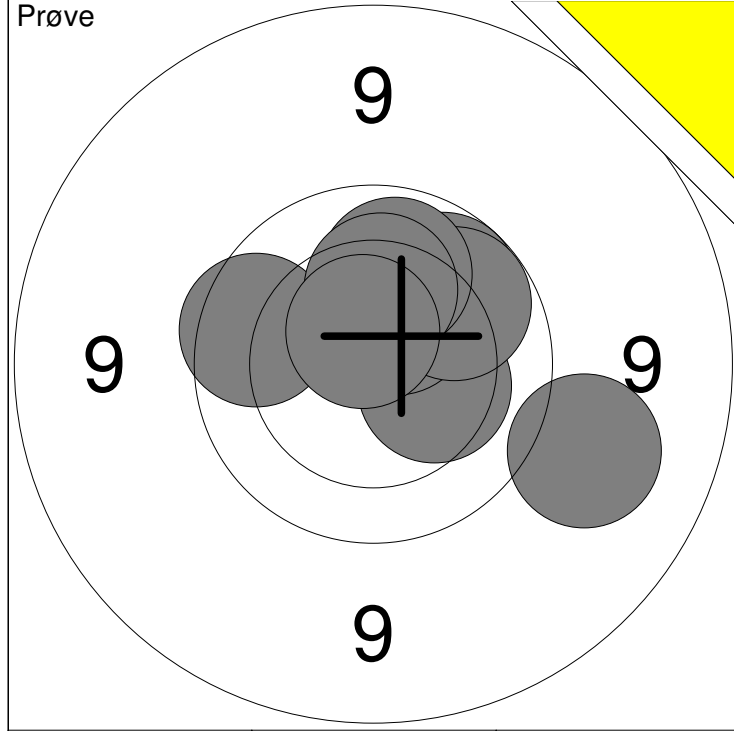

1: 9.2 →	6: 10.2 ↗	Serie	100.7
2: 10.3 →	7: 10.0 ↗		
3: 10.0 ↗	8: 10.0 ↗	Total	398.0
4: 9.8 ←	9: 10.2 ↗		
5: 10.4 ↗	10: 10.6x ↗		

11: 10.5 ↘	Serie	40.6
12: 9.8 ↗		
13: 10.5 ↗	Total	398.0
14: 9.8 ↗		

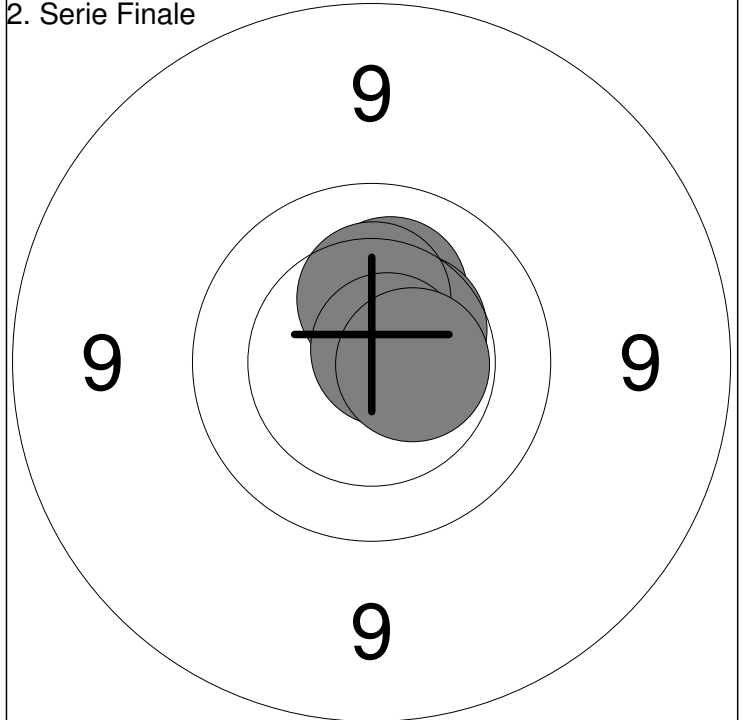
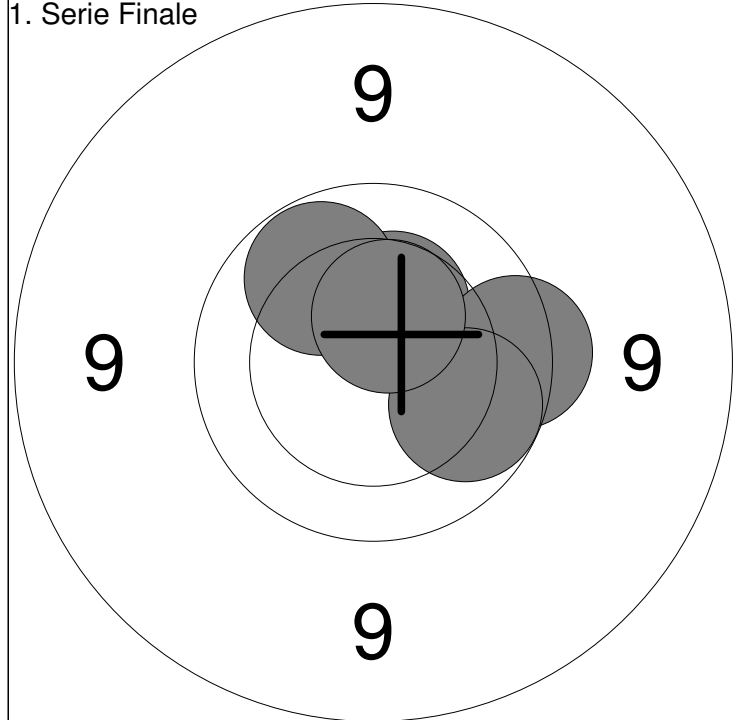

1: 10.4 ↗	Serie	50.6
2: 10.0 ↗		
3: 9.7 →	Total	448.6
4: 10.0 →		
5: 10.5 ↗		

1: 10.2 ↗	Serie	52.2
2: 10.5 ↗		
3: 10.3 ↗	Total	500.8
4: 10.7x ↗		
5: 10.5x →		

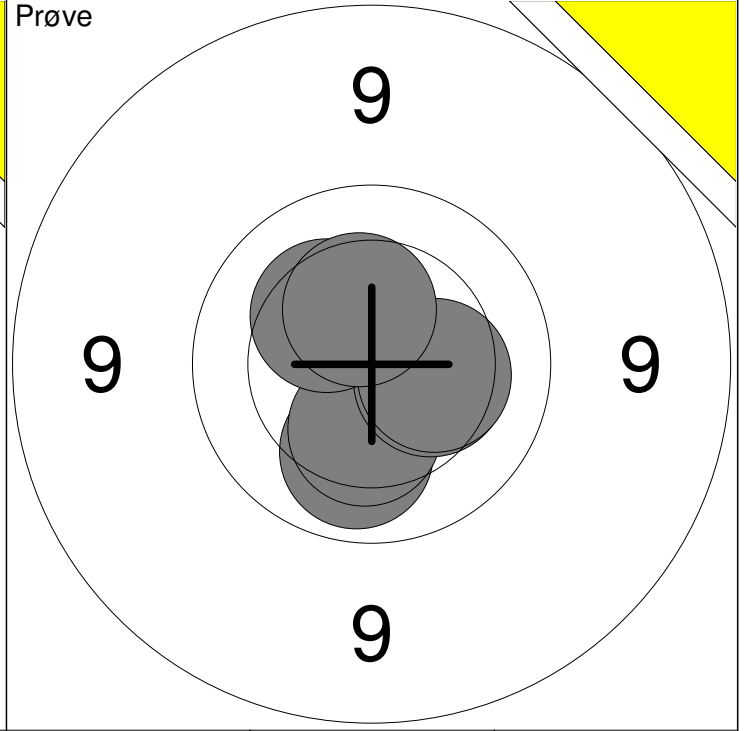
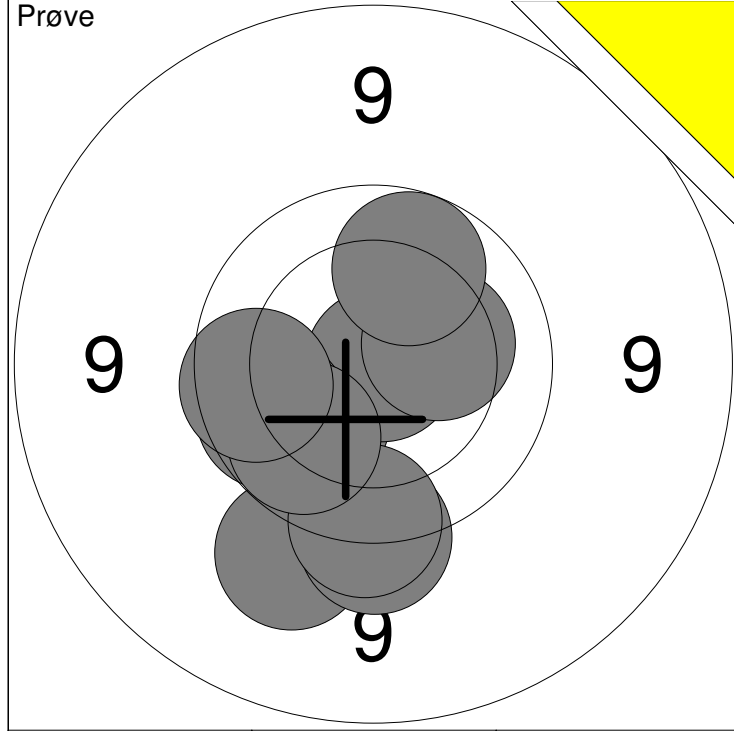

1: 10.2 ↙	6: 9.9 ←	Serie 99.8
2: 10.9x →	7: 10.0 ↙	
3: 9.4 ↙	8: 10.3 →	Total 397.0
4: 9.6 ↓	9: 10.0 ↗	
5: 9.6 ↓	10: 9.9 ←	

11: 10.8x →	16: 10.3 →	Serie 72.5
12: 10.1 ↓	17: 10.4 ↗	
13: 10.3 ↓		Total 397.0
14: 10.3 →		
15: 10.3 ↗		

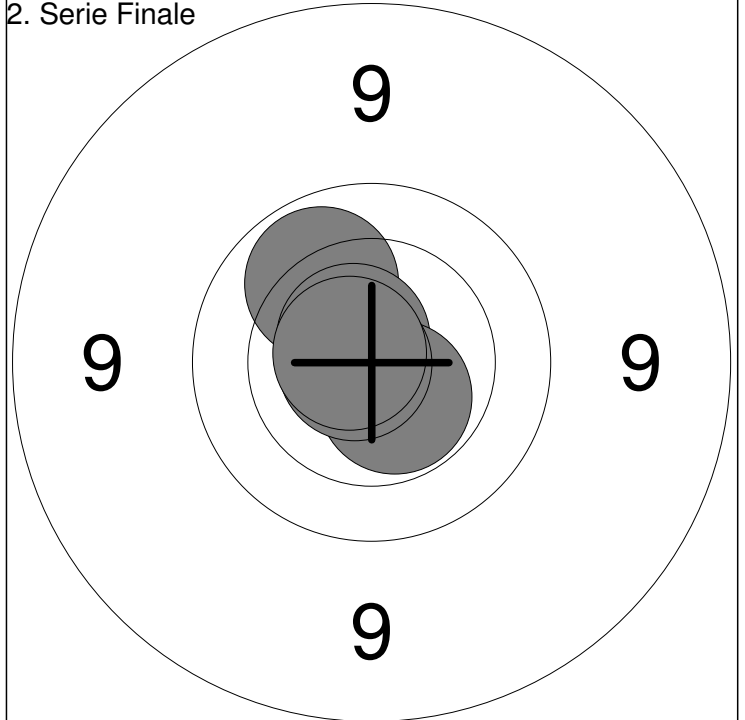
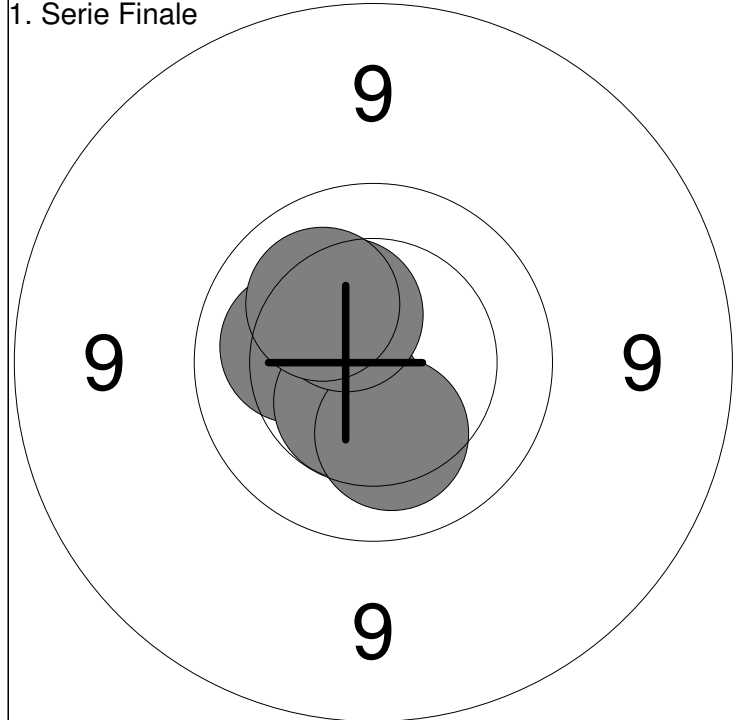

1: 10.2 ↙	Serie 51.5
2: 10.5x ↙	
3: 10.2 ↙	Total 448.5
4: 10.4 ↗	
5: 10.2 ↗	

1: 10.0 ↗	Serie 52.7
2: 10.7x ↗	
3: 10.5x ↙	Total 501.2
4: 10.8x ←	
5: 10.7x ↙	

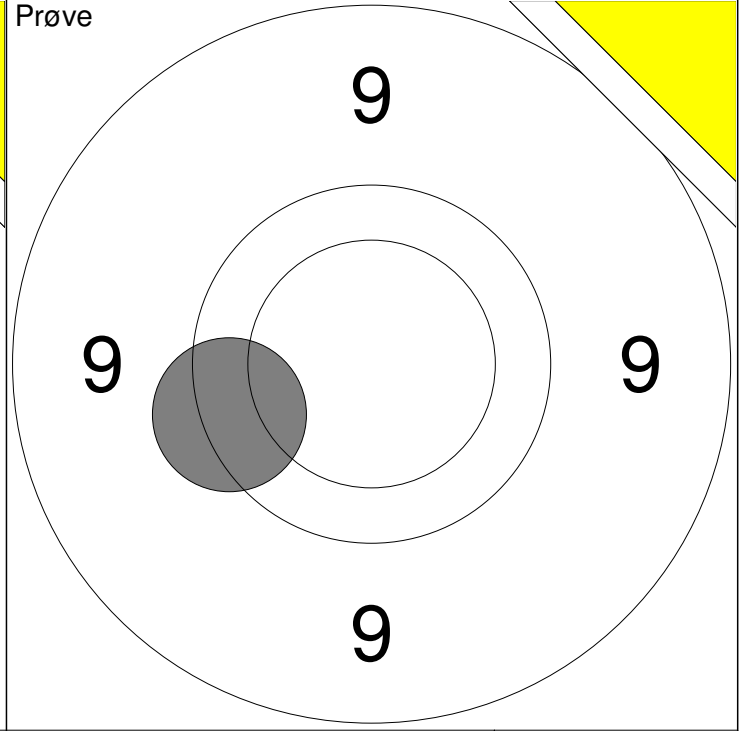
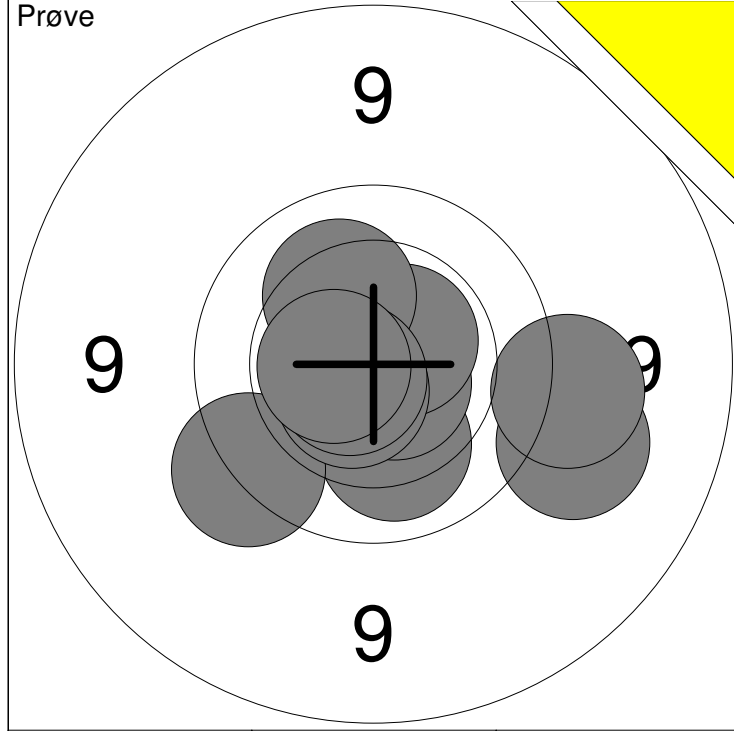

1: 9.3 →	6: 9.6 ↙	Serie	101.8
2: 10.1 ↓	7: 10.2 ↗		
3: 9.4 →	8: 10.6x ↙	Total	397.0
4: 10.7x ↘	9: 10.7x ↙		
5: 10.6x ↗	10: 10.6x ←		

11: 9.7 ←	Serie	9.7
Total		397.0

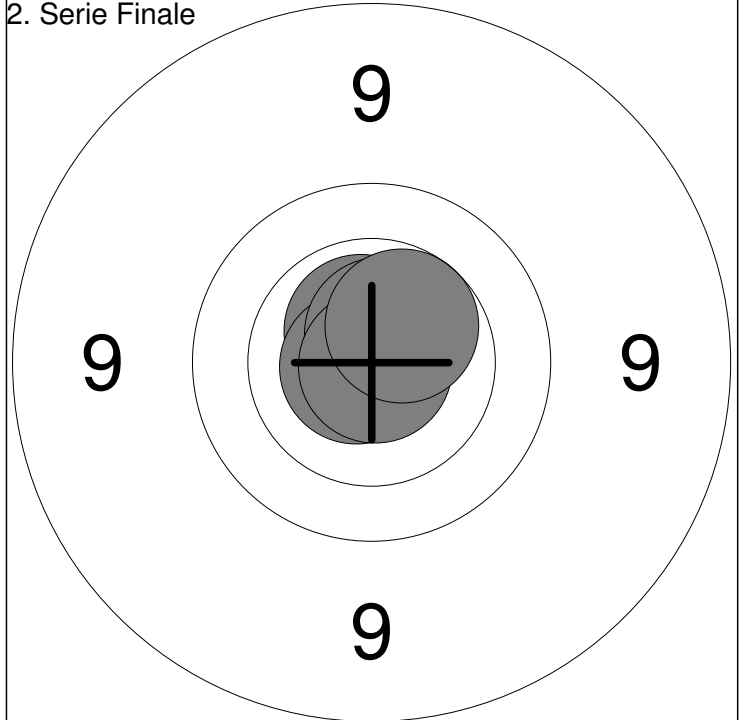
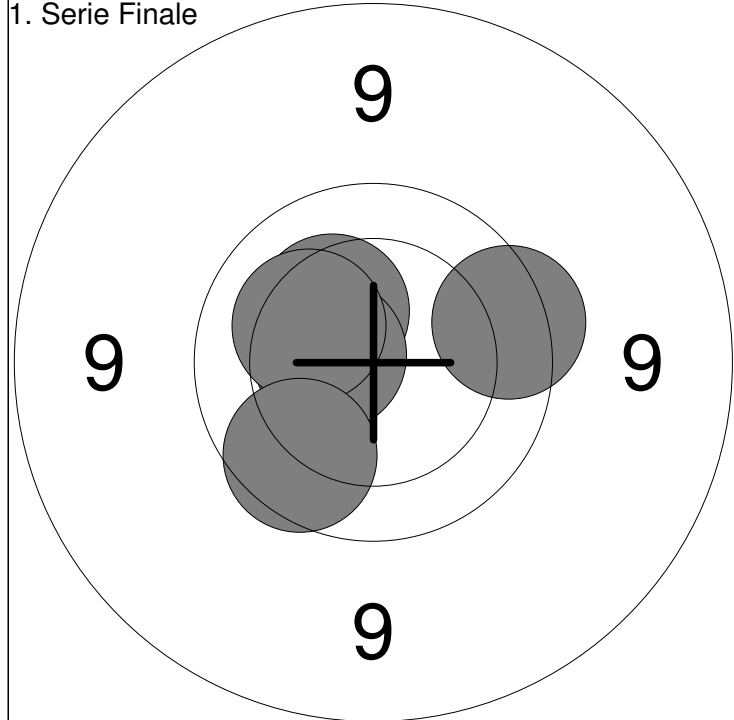

1: 10.3 ↗	Serie	50.6
2: 10.5x ←		
3: 10.2 ↗	Total	447.6
4: 9.9 ↙		
5: 9.7 →		

1: 10.6x ↗	Serie	53.5
2: 10.8x ←		
3: 10.7x ↗	Total	501.1
4: 10.9x ↘		
5: 10.5 ↗		

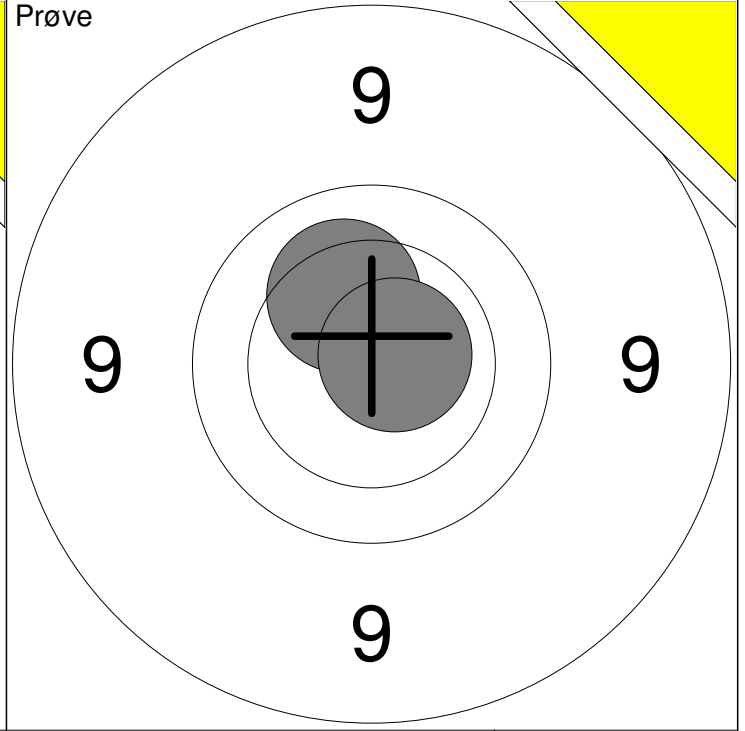
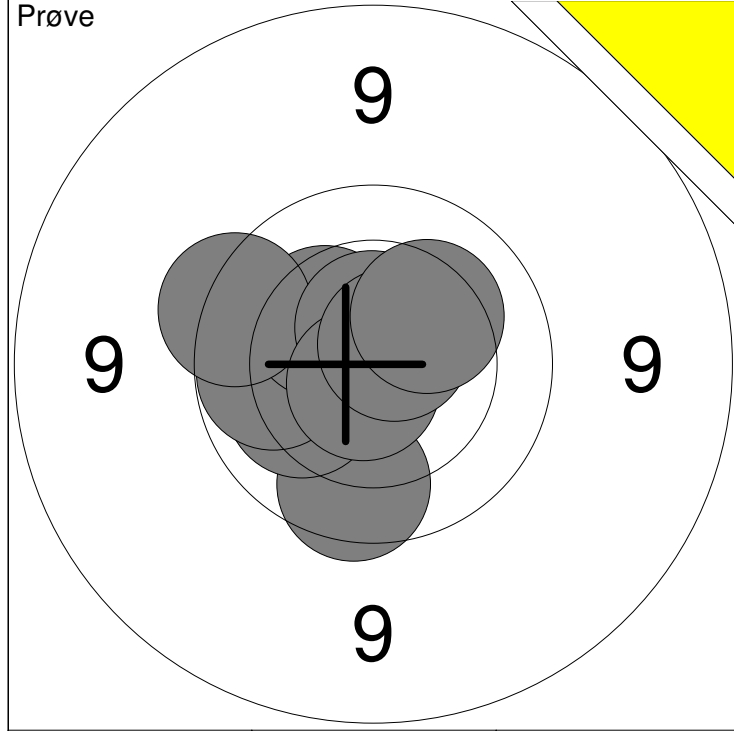

1: 9.8 ↓	6: 9.7 ↙	Serie	102.2
2: 10.2 ↙	7: 10.6x ↑		
3: 9.9 ↙	8: 10.7x ↓	Total	397.0
4: 10.0 ↙	9: 10.7x ↗		
5: 10.3 ↙	10: 10.3 ↗		

11: 10.2 ↖	Serie	20.9
12: 10.7x →		
	Total	397.0

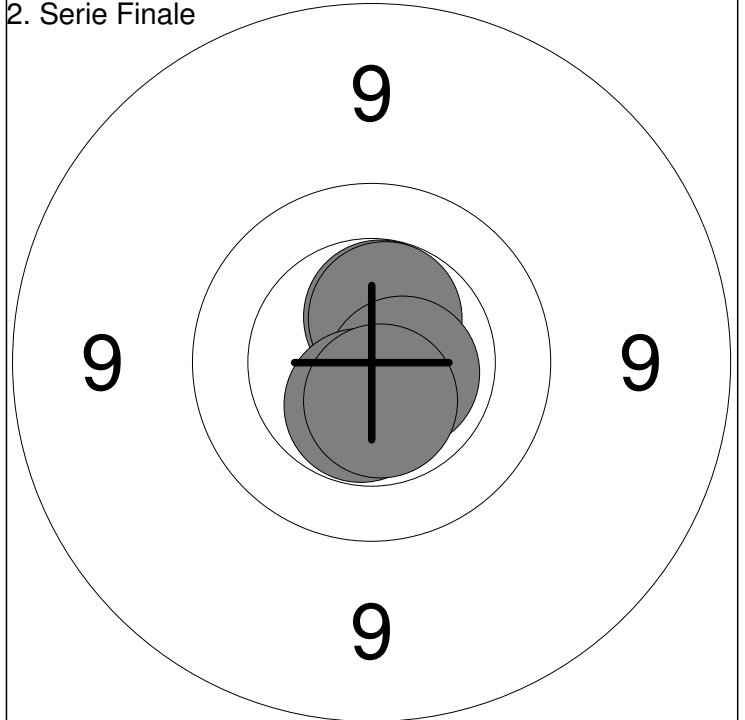
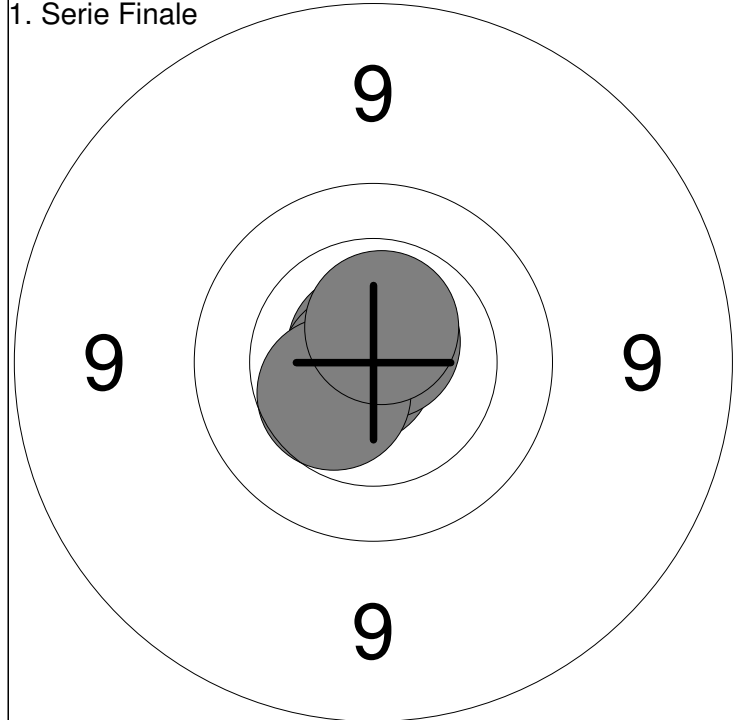

1: 10.8x ↖	Serie	53.4
2: 10.8x ↙		
3: 10.7x ↗	Total	450.4
4: 10.5 ↙		
5: 10.6x ↑		

1: 10.5x ↑	Serie	52.7
2: 10.5x ↑		
3: 10.6x →	Total	503.1
4: 10.5x ↓		
5: 10.6x ↓		



1: 9.7 ←	6: 10.4 ↘	Serie	103.2	11: 9.8 ←	Serie	30.9
2: 9.9 ↓	7: 10.6x ↓			12: 10.7x ↓		
3: 9.6 ↙	8: 10.7x ↘	Total	397.0	13: 10.4 ←	Total	397.0
4: 10.4 ↙	9: 10.5x ↓			5: 10.6x ↓		

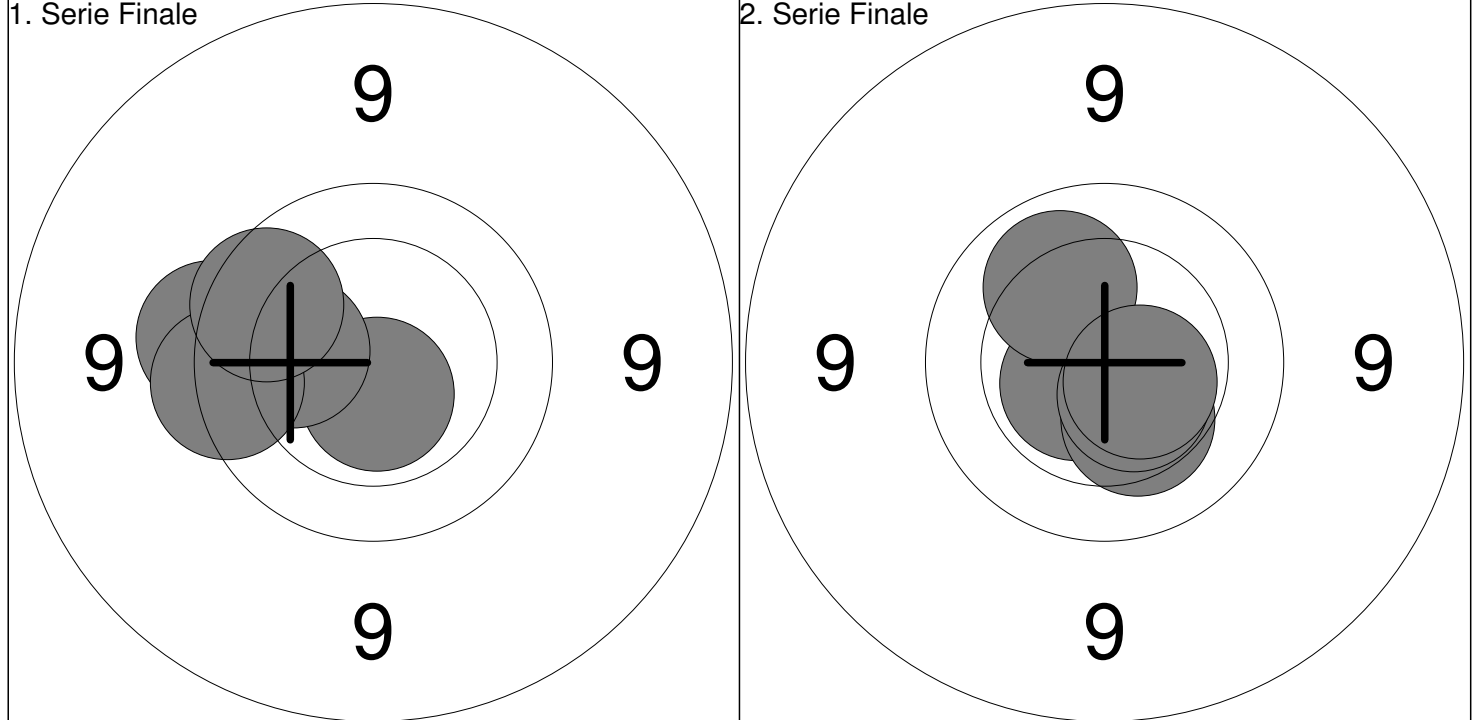

1: 10.6x ↓	Serie	49.9	1: 10.6x ↙	Serie	52.0
2: 9.6 ←			2: 10.3 ↓		
3: 10.2 ←	Total	446.9	3: 10.5x ↘	Total	498.9
4: 9.7 ←			4: 10.1 ↗		
5: 9.8 ↙					

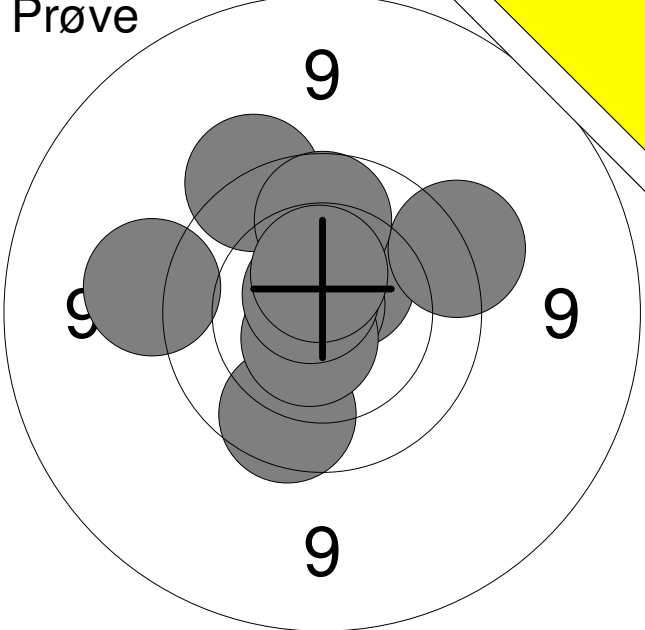
Prøve 	1:	9.4	←
	2:	9.6	↗
	3:	10.5x	↗
	4:	9.8	↓
	5:	10.8x	↗
	6:	10.6x	↓
	7:	10.7x	↗
	8:	9.6	→
	9:	9.9	↑
	10:	10.5x	↑
	Serie		101.4
Total		397.0	

1. Serie Finale 	1:	9.8	↑
	2:	10.5	↖
	3:	10.4	↗
	4:	9.9	↗
	5:	9.9	↗
	Serie		50.5
Total		447.5	

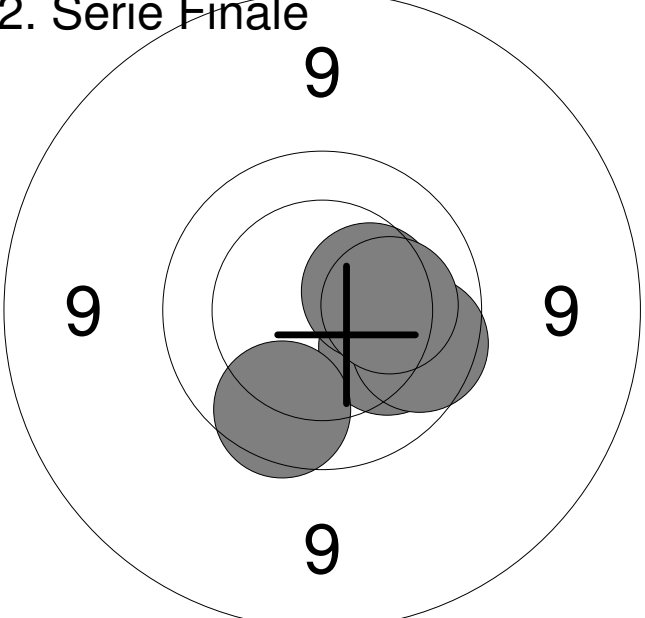
2. Serie Finale 	1:	10.1	↘
	2:	10.4	→
	3:	9.8	↓
	4:	9.9	→
	5:	10.2	→
	Serie		50.4
Total		497.9	

Hold 3	Skive 1	Mia Meyer Jensen	
------------------	-------------------	-------------------------	--

Aalborg	Karup	Åben	S
---------	-------	------	---

02.03.2018	Nordjysk mesterskab Finaler	Aalborg Skyttekreds
------------	-----------------------------	---------------------

Prøve 	1:	9.5	→
	2:	10.3	→
	3:	10.5x	↑
	4:	9.8	→
	5:	10.7x	↓
	6:	10.3	←
	7:	10.4	↗
	8:	10.2	↖
	9:	10.2	→
	Serie		91.9
Total		400.0	

1. Serie Finale 	1:	10.8x	↗
	2:	10.2	↓
	3:	10.2	←
	4:	10.4	↑
	5:	10.1	←
Serie		51.7	
Total		451.7	

2. Serie Finale 	1:	9.7	←
	2:	10.6x	↓
	3:	10.3	→
	4:	10.5x	←
	5:	10.3	→
Serie		51.4	
Total		503.1	

<p>Prøve</p>	<table style="width:100%; border-collapse: collapse;"> <tr><td style="width:5%;">1:</td><td style="width:15%;">9.7</td><td style="width:10%; text-align: right;">↓</td></tr> <tr><td>2:</td><td>10.5</td><td style="text-align: right;">←</td></tr> <tr><td>3:</td><td>10.3</td><td style="text-align: right;">↓</td></tr> <tr><td>4:</td><td>10.8x</td><td style="text-align: right;">→</td></tr> <tr><td>5:</td><td>9.9</td><td style="text-align: right;">←</td></tr> <tr><td>6:</td><td>10.1</td><td style="text-align: right;">↓</td></tr> <tr><td>7:</td><td>10.7x</td><td style="text-align: right;">↓</td></tr> <tr><td>8:</td><td>10.1</td><td style="text-align: right;">←</td></tr> <tr><td>9:</td><td>10.3</td><td style="text-align: right;">↑</td></tr> </table> <table border="1" style="width:100%; border-collapse: collapse; margin-top: 5px;"> <tr> <td style="width:80%;">Serie</td> <td style="text-align: right;">92.4</td> </tr> <tr> <td>Total</td> <td style="text-align: right;">399.0</td> </tr> </table>	1:	9.7	↓	2:	10.5	←	3:	10.3	↓	4:	10.8x	→	5:	9.9	←	6:	10.1	↓	7:	10.7x	↓	8:	10.1	←	9:	10.3	↑	Serie	92.4	Total	399.0
1:	9.7	↓																														
2:	10.5	←																														
3:	10.3	↓																														
4:	10.8x	→																														
5:	9.9	←																														
6:	10.1	↓																														
7:	10.7x	↓																														
8:	10.1	←																														
9:	10.3	↑																														
Serie	92.4																															
Total	399.0																															

<p>1. Serie Finale</p>	<table style="width:100%; border-collapse: collapse;"> <tr><td style="width:5%;">1:</td><td style="width:15%;">10.1</td><td style="width:10%; text-align: right;">↑</td></tr> <tr><td>2:</td><td>10.2</td><td style="text-align: right;">↓</td></tr> <tr><td>3:</td><td>10.3</td><td style="text-align: right;">←</td></tr> <tr><td>4:</td><td>10.7x</td><td style="text-align: right;">↓</td></tr> <tr><td>5:</td><td>10.5x</td><td style="text-align: right;">↗</td></tr> </table> <table border="1" style="width:100%; border-collapse: collapse; margin-top: 5px;"> <tr> <td style="width:80%;">Serie</td> <td style="text-align: right;">51.8</td> </tr> <tr> <td>Total</td> <td style="text-align: right;">450.8</td> </tr> </table>	1:	10.1	↑	2:	10.2	↓	3:	10.3	←	4:	10.7x	↓	5:	10.5x	↗	Serie	51.8	Total	450.8
1:	10.1	↑																		
2:	10.2	↓																		
3:	10.3	←																		
4:	10.7x	↓																		
5:	10.5x	↗																		
Serie	51.8																			
Total	450.8																			

<p>2. Serie Finale</p>	<table style="width:100%; border-collapse: collapse;"> <tr><td style="width:5%;">1:</td><td style="width:15%;">10.4</td><td style="width:10%; text-align: right;">←</td></tr> <tr><td>2:</td><td>10.4</td><td style="text-align: right;">←</td></tr> <tr><td>3:</td><td>10.4</td><td style="text-align: right;">↓</td></tr> <tr><td>4:</td><td>10.2</td><td style="text-align: right;">↑</td></tr> <tr><td>5:</td><td>10.1</td><td style="text-align: right;">←</td></tr> </table> <table border="1" style="width:100%; border-collapse: collapse; margin-top: 5px;"> <tr> <td style="width:80%;">Serie</td> <td style="text-align: right;">51.5</td> </tr> <tr> <td>Total</td> <td style="text-align: right;">502.3</td> </tr> </table>	1:	10.4	←	2:	10.4	←	3:	10.4	↓	4:	10.2	↑	5:	10.1	←	Serie	51.5	Total	502.3
1:	10.4	←																		
2:	10.4	←																		
3:	10.4	↓																		
4:	10.2	↑																		
5:	10.1	←																		
Serie	51.5																			
Total	502.3																			

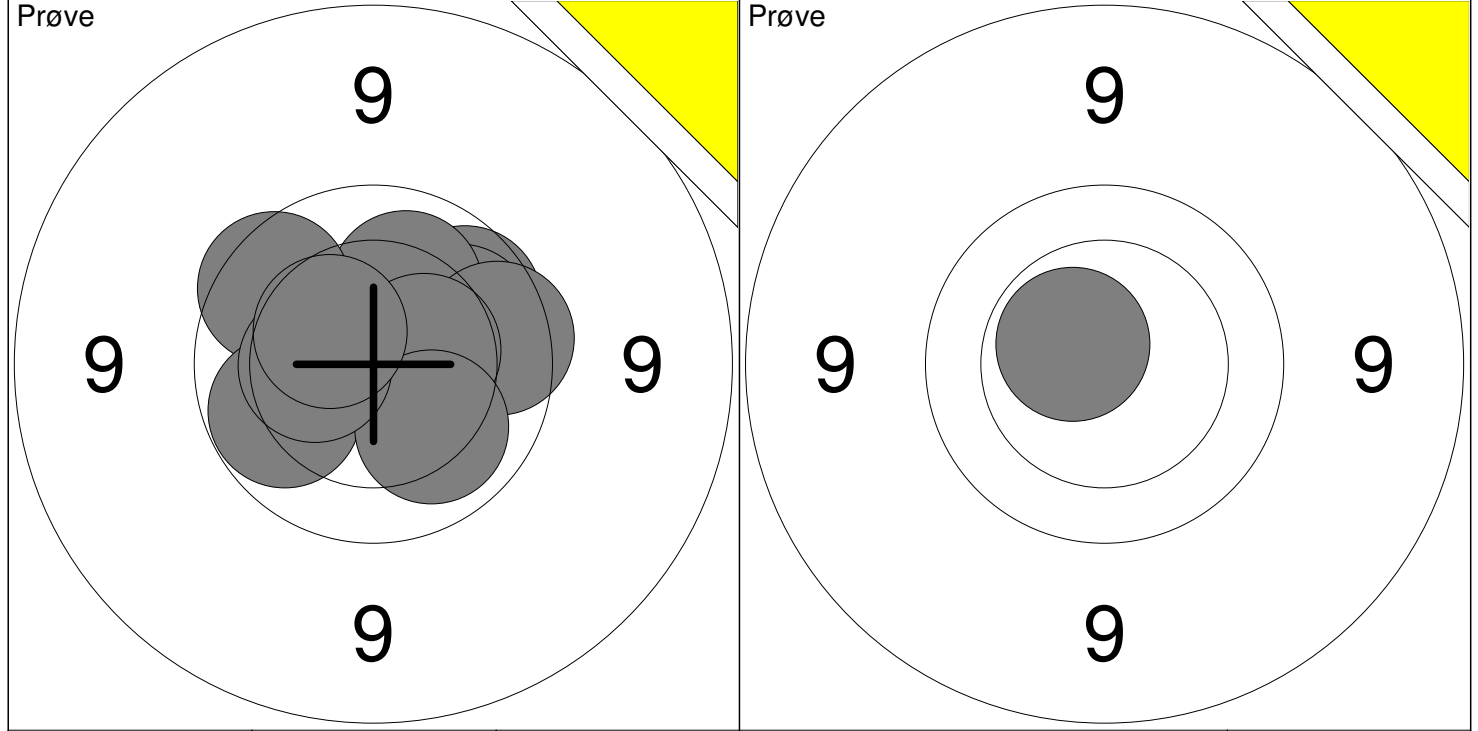

1: 9.9 ↗	6: 10.0 ←	Serie	100.9		Serie	10.6
2: 10.0 ↗	7: 10.4 →			11: 10.6x ↖		
3: 10.1 ↑	8: 10.1 ↘	Total	399.0		Total	399.0
4: 9.8 →	9: 10.4 ←			10: 10.4 ↗		
5: 9.8 ↖						

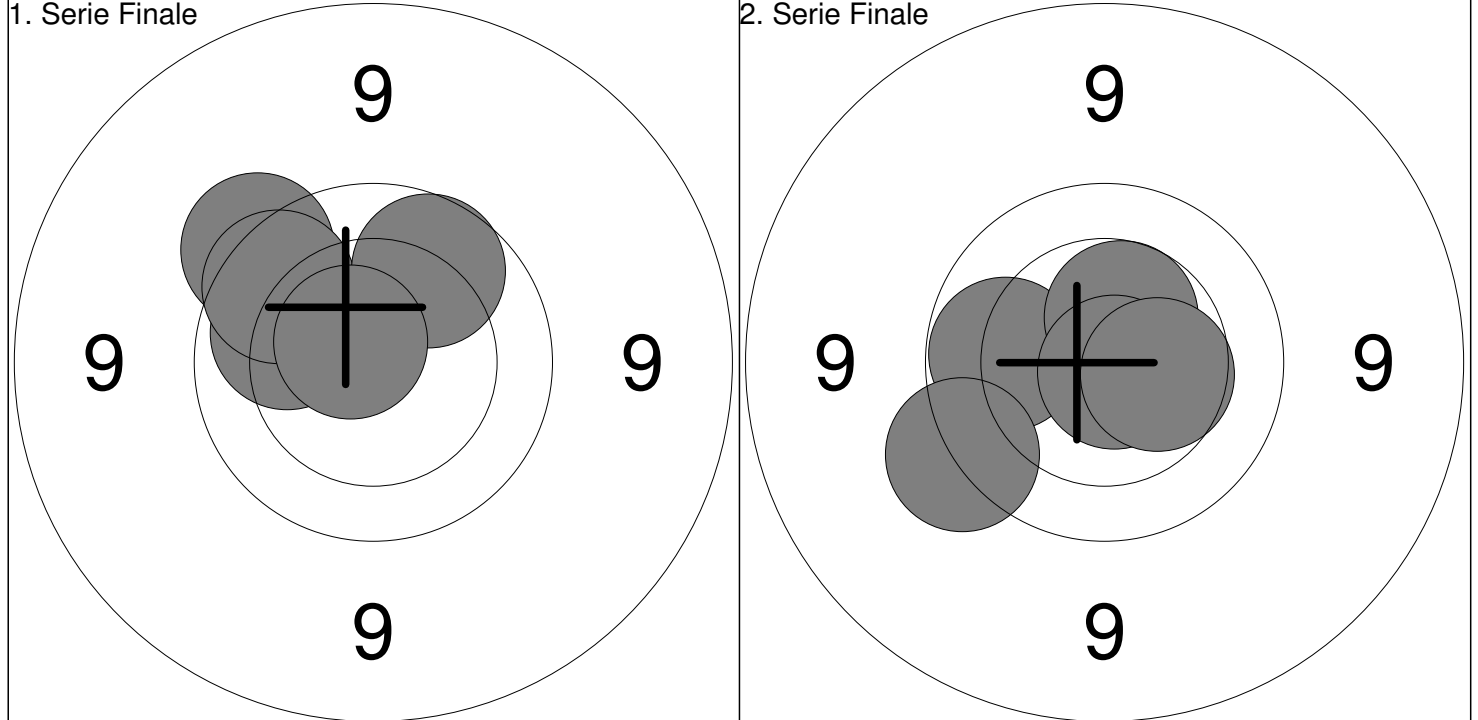

1: 10.1 ↖	Serie	50.1		Serie	51.3
2: 9.6 ↗			1: 10.0 ←		
3: 9.8 ↗	Total	449.1		Total	500.4
4: 9.9 ↗			3: 10.5 ↑		
5: 10.7x ↖			5: 10.4 →		

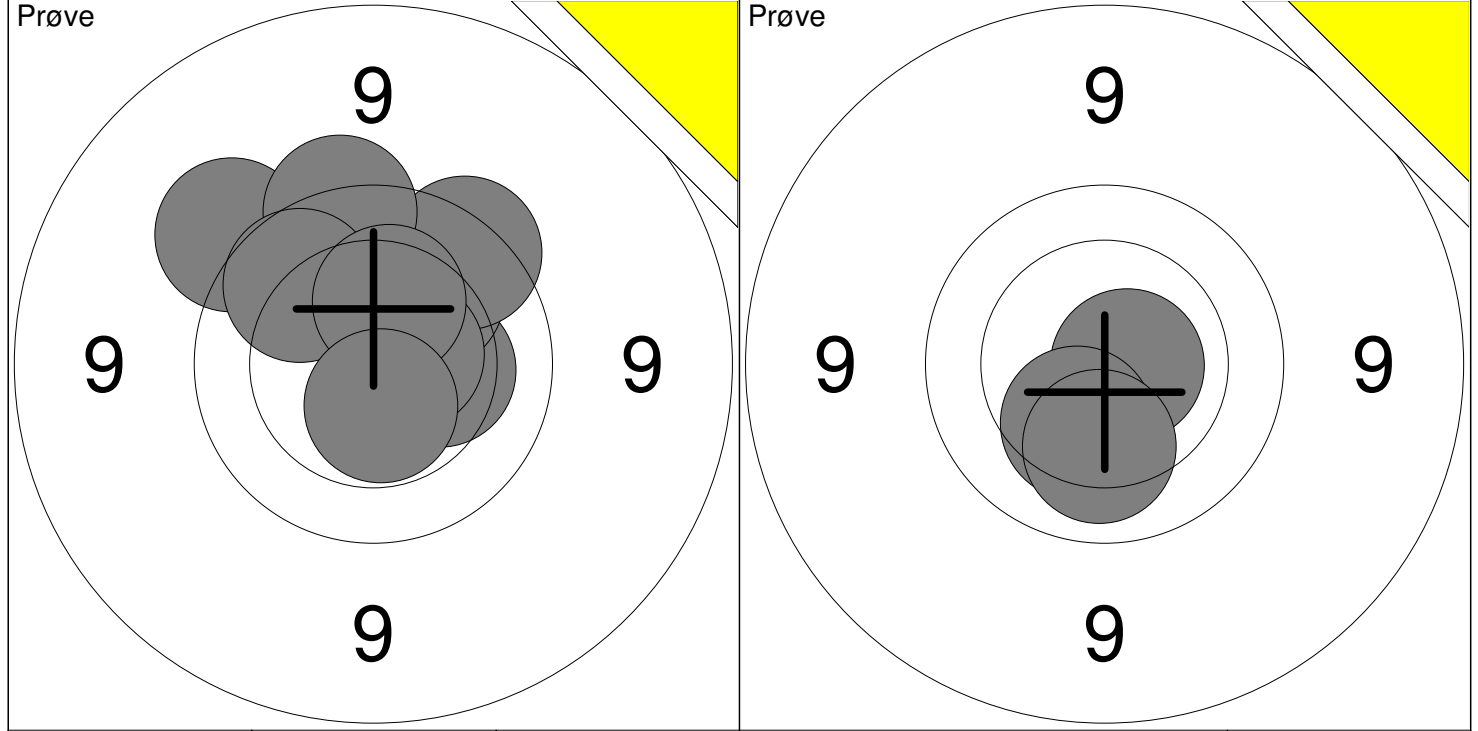

1: 9.5 ↖	6: 10.6x →	Serie	101.2	11: 10.7x →	Serie	31.1
2: 10.3 →	7: 10.6x →			12: 10.3 ↓		
3: 10.1 ↗	8: 9.9 ↖	Total	399.0	13: 10.1 ↓	Total	399.0
4: 9.7 ↗	9: 10.3 ↗			5: 9.7 ↗		

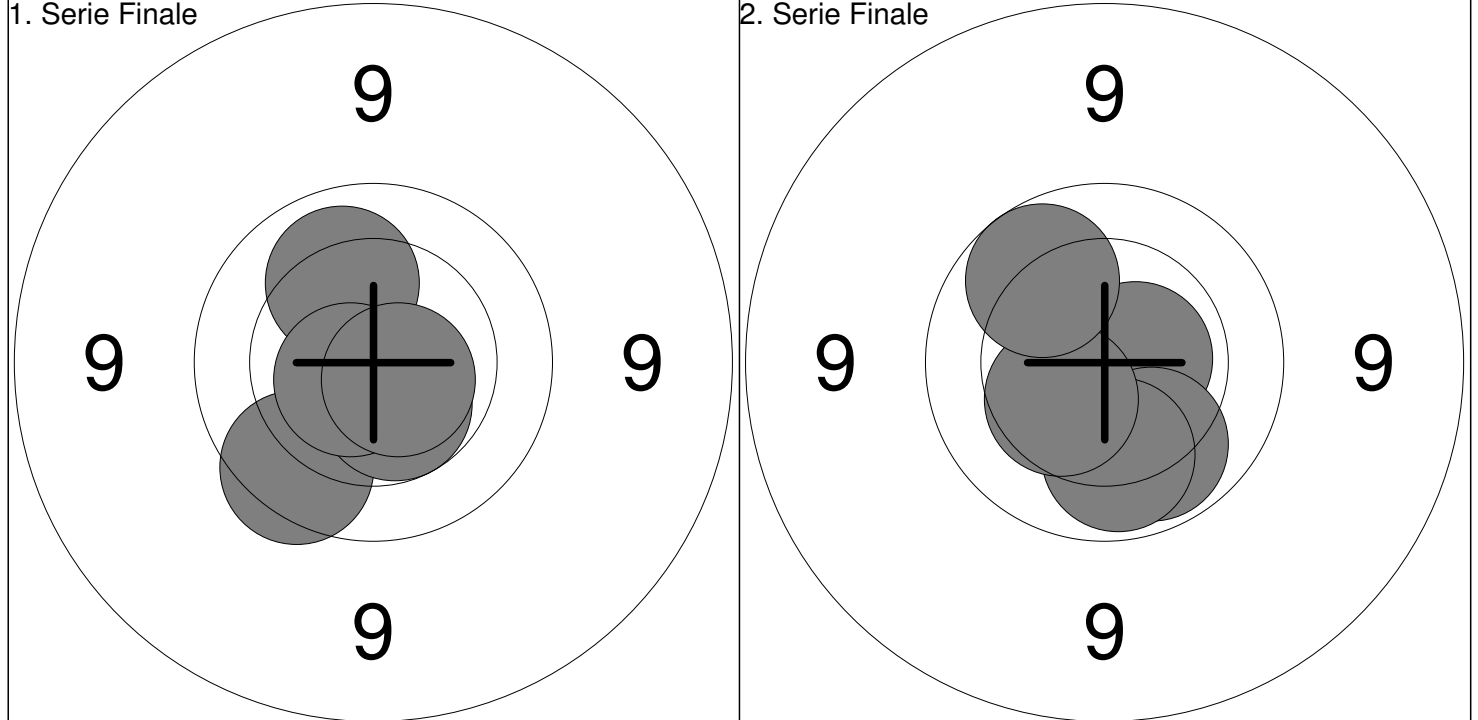

1: 9.8 ↙	Serie	51.8	1: 10.6x →	Serie	50.9
2: 10.1 ↗			2: 10.0 ↓		
3: 10.5 ↓	Total	450.8	3: 10.0 ↓	Total	501.7
4: 10.7x ↙			4: 10.4 ↙		
5: 10.7x ↘					

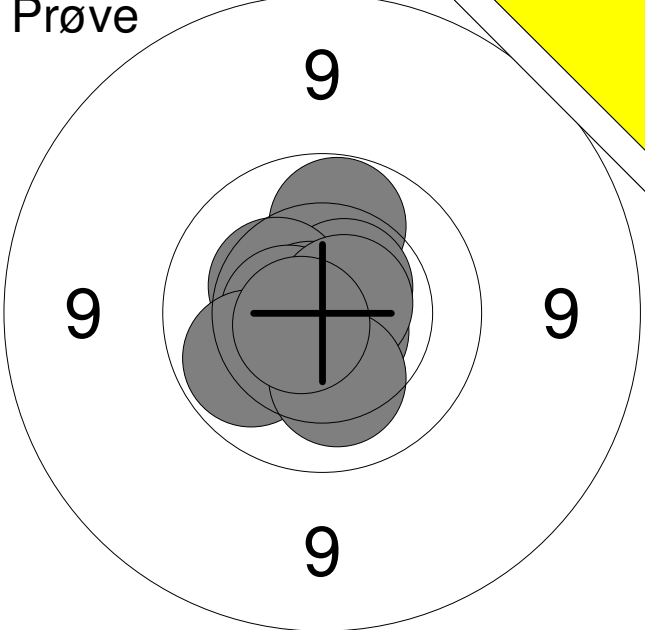
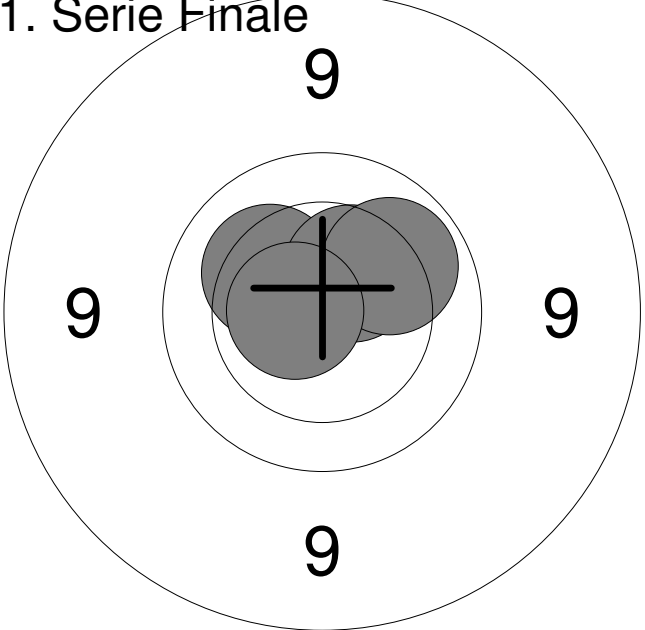
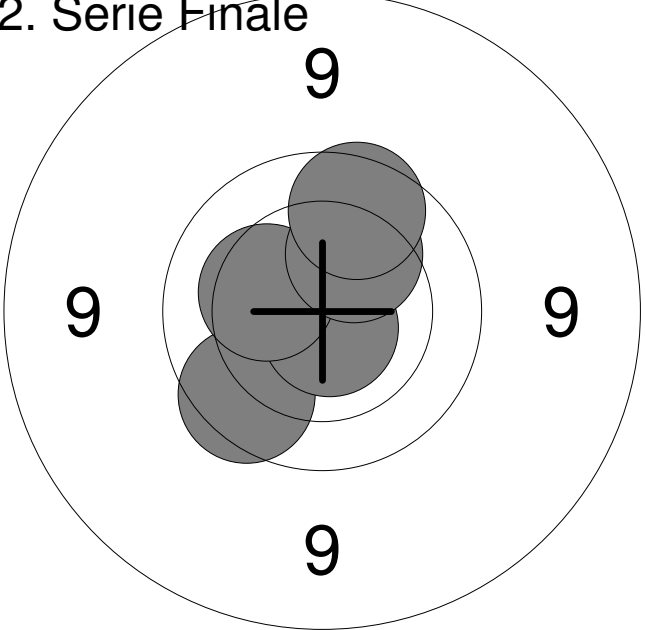
02.03.2018	Nordjysk mesterskab Finaler	Aalborg Skyttekreds																													
Prøve 	<table style="width:100%; border-collapse: collapse;"> <tr><td>1:</td><td>10.7x</td><td style="text-align: right;">↘</td></tr> <tr><td>2:</td><td>10.0</td><td style="text-align: right;">↑</td></tr> <tr><td>3:</td><td>10.6x</td><td style="text-align: right;">↗</td></tr> <tr><td>4:</td><td>10.4</td><td style="text-align: right;">↖</td></tr> <tr><td>5:</td><td>10.8x</td><td style="text-align: right;">←</td></tr> <tr><td>6:</td><td>10.6x</td><td style="text-align: right;">←</td></tr> <tr><td>7:</td><td>10.7x</td><td style="text-align: right;">↗</td></tr> <tr><td>8:</td><td>10.0</td><td style="text-align: right;">↖</td></tr> <tr><td>9:</td><td>10.2</td><td style="text-align: right;">↓</td></tr> <tr><td>10:</td><td>10.7x</td><td style="text-align: right;">↖</td></tr> </table>	1:	10.7x	↘	2:	10.0	↑	3:	10.6x	↗	4:	10.4	↖	5:	10.8x	←	6:	10.6x	←	7:	10.7x	↗	8:	10.0	↖	9:	10.2	↓	10:	10.7x	↖
1:	10.7x	↘																													
2:	10.0	↑																													
3:	10.6x	↗																													
4:	10.4	↖																													
5:	10.8x	←																													
6:	10.6x	←																													
7:	10.7x	↗																													
8:	10.0	↖																													
9:	10.2	↓																													
10:	10.7x	↖																													
Serie		104.7																													
Total		399.0																													
1. Serie Finale 	<table style="width:100%; border-collapse: collapse;"> <tr><td>1:</td><td>10.6x</td><td style="text-align: right;">↖</td></tr> <tr><td>2:</td><td>10.2</td><td style="text-align: right;">↖</td></tr> <tr><td>3:</td><td>10.4</td><td style="text-align: right;">↗</td></tr> <tr><td>4:</td><td>10.0</td><td style="text-align: right;">↗</td></tr> <tr><td>5:</td><td>10.6x</td><td style="text-align: right;">←</td></tr> </table>	1:	10.6x	↖	2:	10.2	↖	3:	10.4	↗	4:	10.0	↗	5:	10.6x	←															
1:	10.6x	↖																													
2:	10.2	↖																													
3:	10.4	↗																													
4:	10.0	↗																													
5:	10.6x	←																													
Serie		51.8																													
Total		450.8																													
2. Serie Finale 	<table style="width:100%; border-collapse: collapse;"> <tr><td>1:</td><td>9.8</td><td style="text-align: right;">↙</td></tr> <tr><td>2:</td><td>10.7x</td><td style="text-align: right;">↓</td></tr> <tr><td>3:</td><td>10.3</td><td style="text-align: right;">↖</td></tr> <tr><td>4:</td><td>10.2</td><td style="text-align: right;">↗</td></tr> <tr><td>5:</td><td>9.8</td><td style="text-align: right;">↗</td></tr> </table>	1:	9.8	↙	2:	10.7x	↓	3:	10.3	↖	4:	10.2	↗	5:	9.8	↗															
1:	9.8	↙																													
2:	10.7x	↓																													
3:	10.3	↖																													
4:	10.2	↗																													
5:	9.8	↗																													
Serie		50.8																													
Total		501.6																													

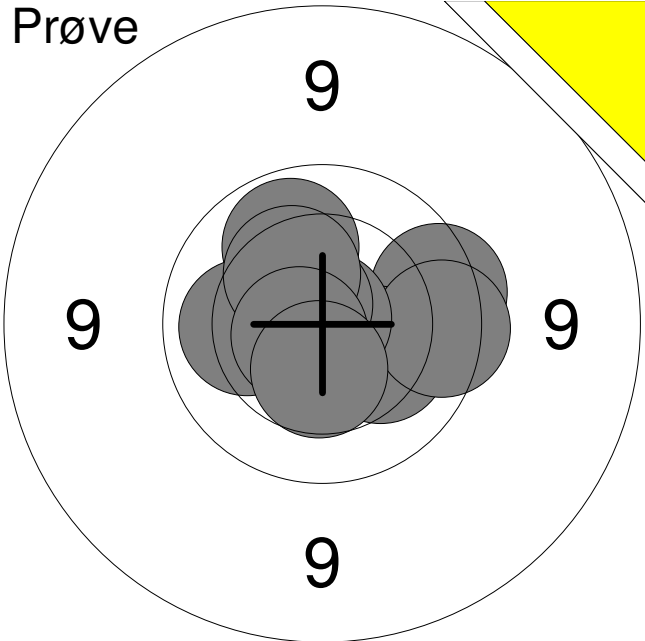
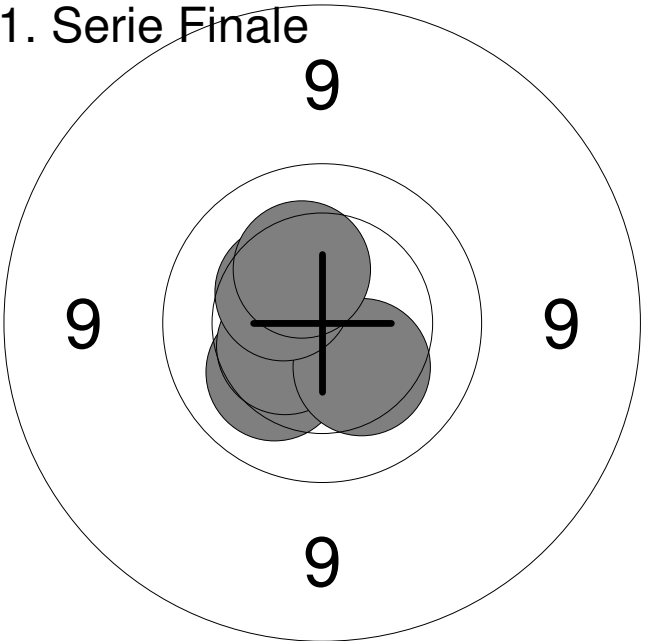
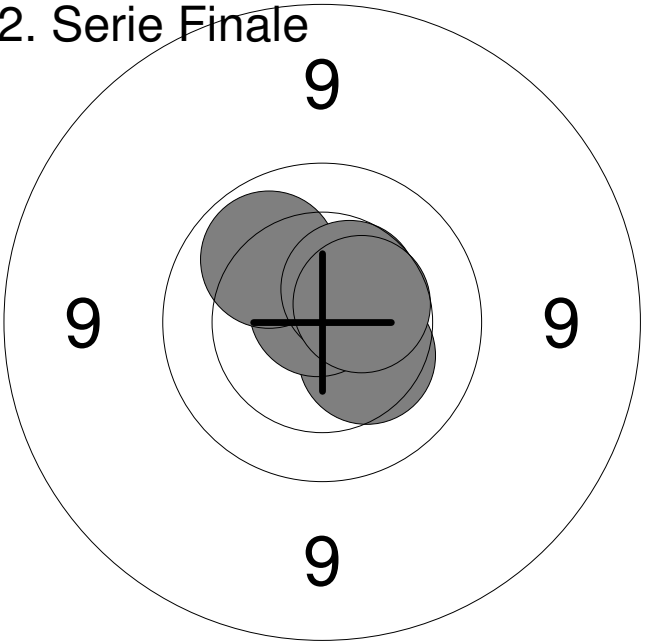
Hold 3	Skive 9	Rene Stricker Jensen		
Aalborg		Vodskov Skytteforening		Åben S
02.03.2018		Nordjysk mesterskab Finaler		Aalborg Skyttekreds
Prøve			1: 9.8	→
			2: 10.2	↘
			3: 9.8	→
			4: 10.0	↑
			5: 10.1	←
			6: 10.9x	↑
			7: 10.7x	↗
			8: 10.3	↗
			9: 10.7x	↖
			10: 10.4	↓
			Serie	102.9
		Total	399.0	
1. Serie Finale			1: 10.2	↙
			2: 10.5	↙
			3: 10.3	↘
			4: 10.4	↗
			5: 10.3	↗
			Serie	51.7
		Total	450.7	
2. Serie Finale			1: 10.3	↘
			2: 10.8x	↑
			3: 10.0	↗
			4: 10.5	↗
			5: 10.5	→
			Serie	52.1
		Total	502.8	

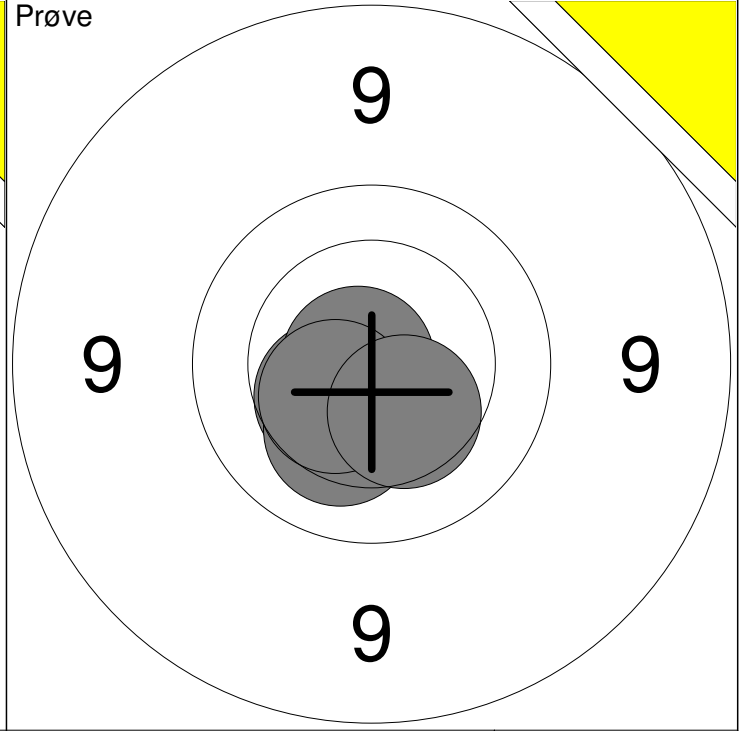
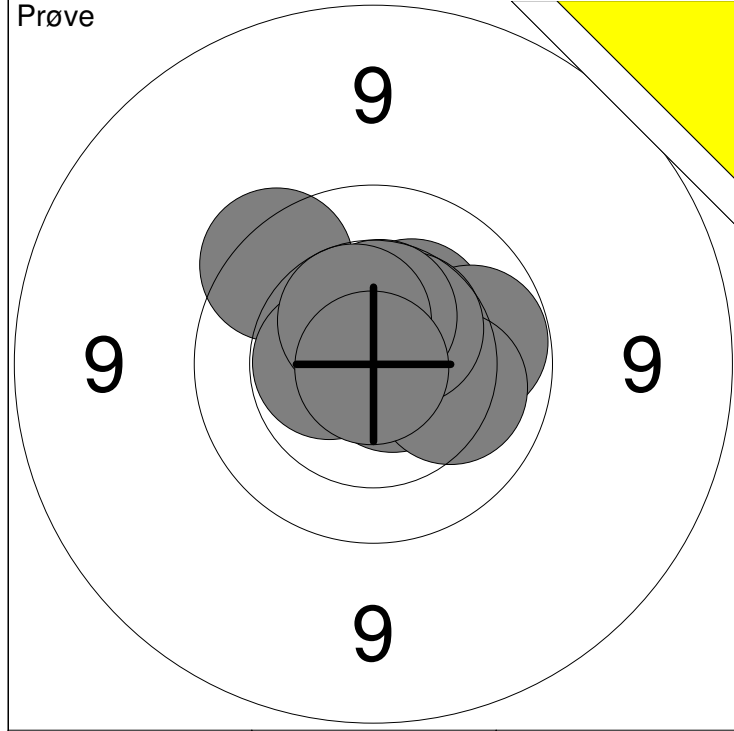

1: 9.7 ↖	6: 10.2 →	Serie 103.8
2: 10.3 ↗	7: 10.5 ↗	
3: 10.7x ↘	8: 10.5 ↑	Total 398.0
4: 10.5x ←	9: 10.5 ↖	
5: 10.0 →	10: 10.9x ↓	

11: 10.4 ↙	Serie 52.3
12: 10.8x ←	
13: 10.2 ↓	Total 398.0
14: 10.5 ↙	
15: 10.4 ↓	

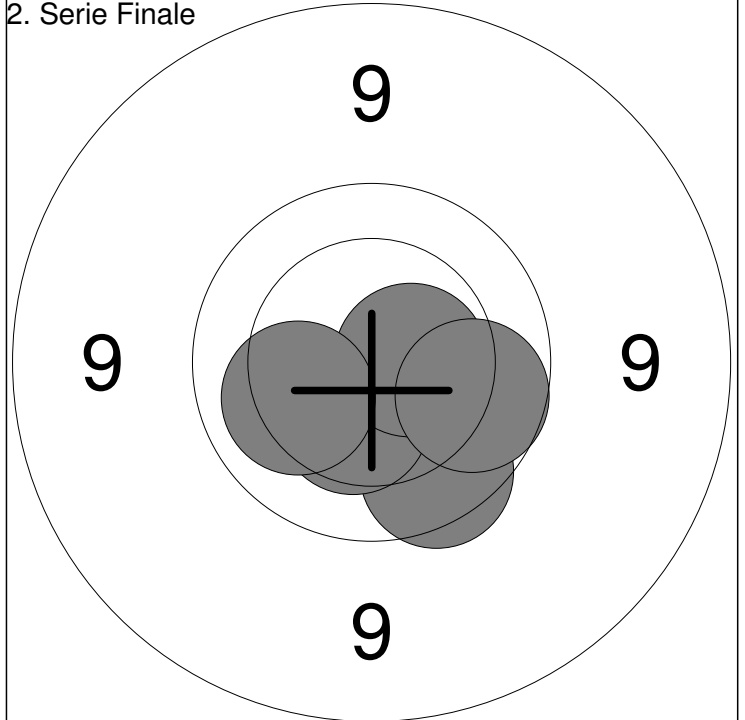
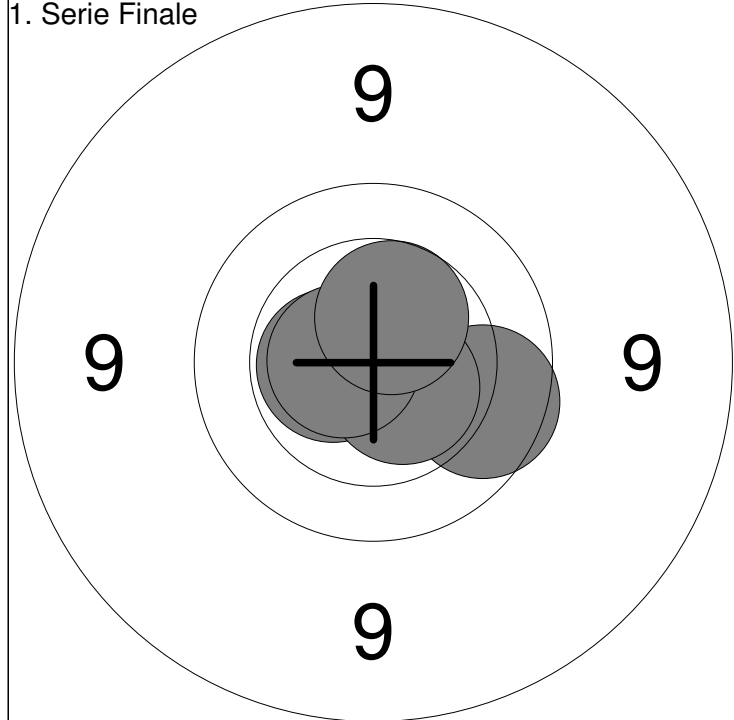

1: 9.9 →	Serie 52.3
2: 10.6x ←	
3: 10.6x ↘	Total 450.3
4: 10.7x ←	
5: 10.5 ↗	

1: 9.8 ↓	Serie 50.9
2: 10.4 ↓	
3: 10.6x →	Total 501.2
4: 9.9 →	
5: 10.2 ←	

Prøve 	1:	10.4	→
	2:	10.7x	←
	3:	10.5x	↖
	4:	9.9	↗
	5:	9.8	↑
	6:	9.9	↖
	7:	10.7x	↘
	8:	10.4	←
	9:	10.2	↖
	10:	10.8x	↗
	Serie		103.3
Total		397.0	

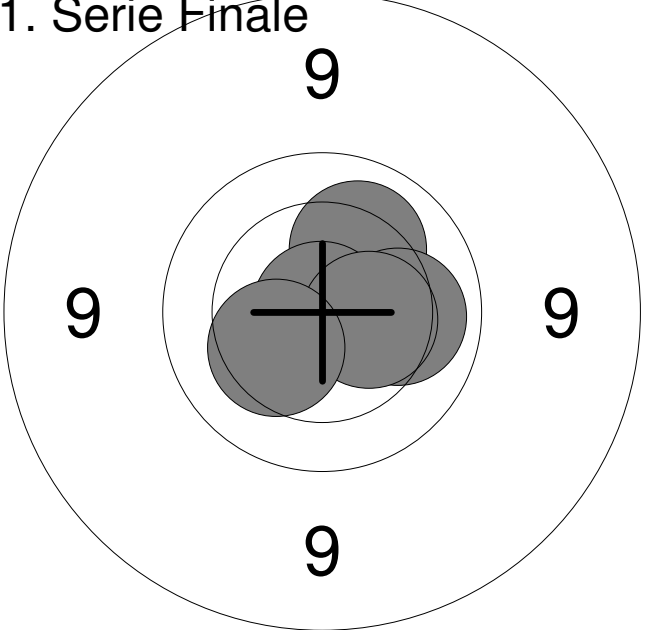
1. Serie Finale 	1:	10.2	↗
	2:	10.9x	↖
	3:	10.1	→
	4:	10.4	→
	5:	10.3	↘
	Serie		51.9
Total		448.9	

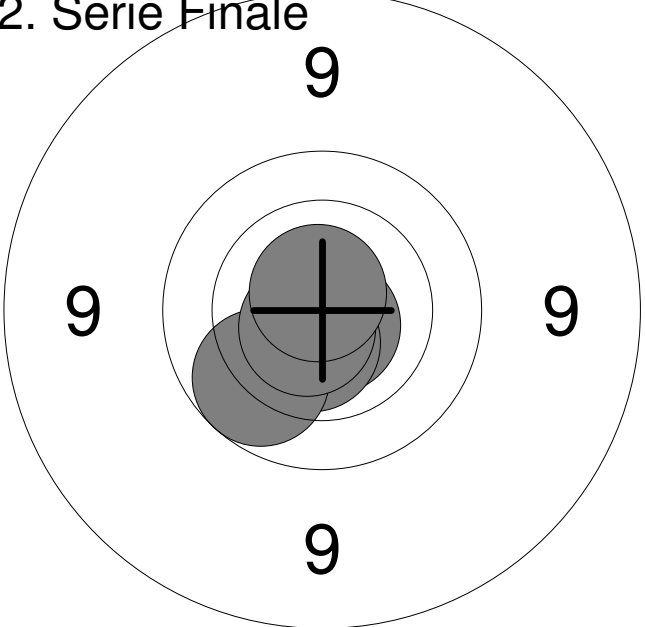
2. Serie Finale 	1:	10.8x	↘
	2:	10.6x	↘
	3:	9.9	↘
	4:	10.7x	↘
	5:	10.8x	↑
	Serie		52.8
Total		501.7	

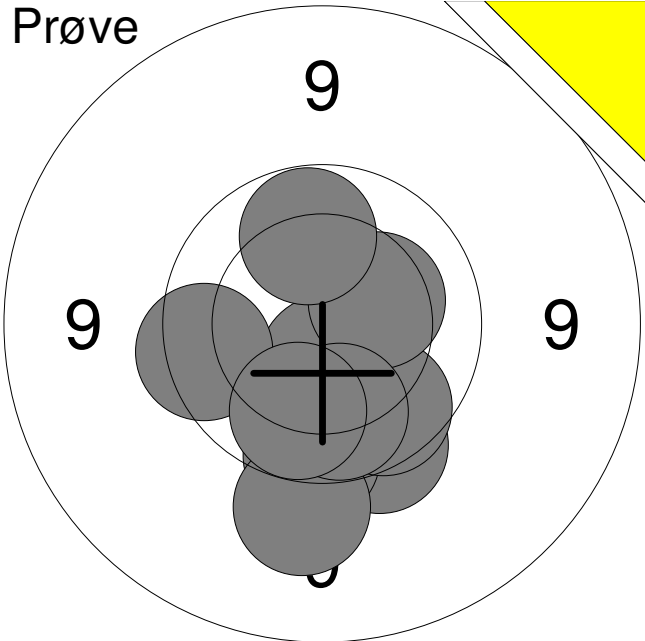
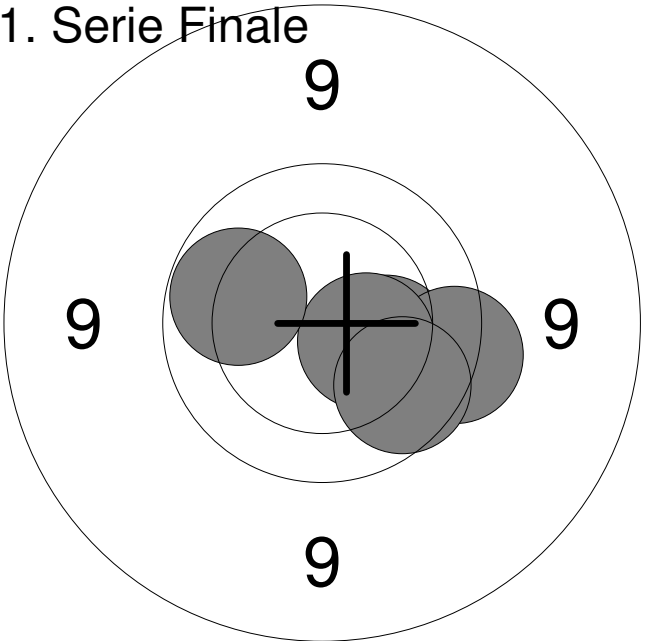
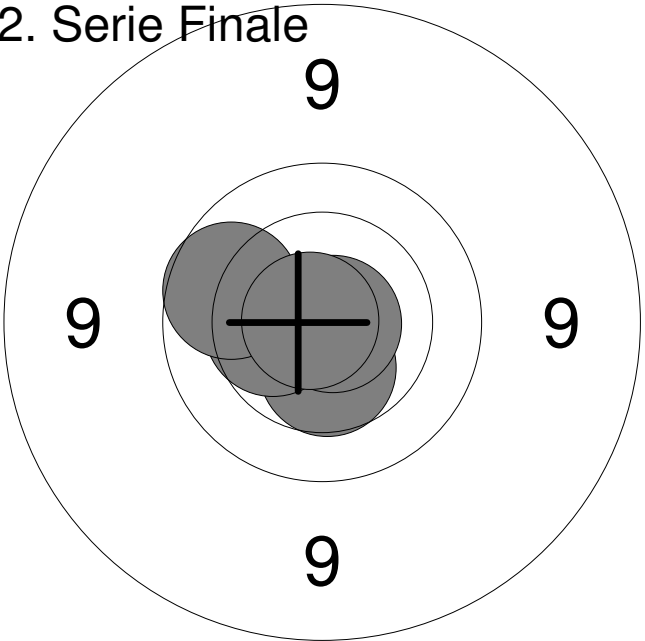
Hold 4	Skive 1	Anton Christensen		
Aalborg		Frederikshavn Skyttekreds		Stilling S
02.03.2018		Nordjysk mesterskab Finaler		Aalborg Skyttekreds
Prøve				
		1:	10.5x	↓
		2:	9.7	↓
		3:	9.8	←
		4:	9.7	↓
		5:	9.4	↓
		6:	9.9	↘
		7:	10.3	→
		8:	10.0	↑
		9:	10.0	↓
		10:	10.0	↓
		Serie		99.3
		Total		391.0
1. Serie Finale				
		1:	10.2	→
		2:	9.7	→
		3:	10.4	→
		4:	10.0	←
		5:	9.9	↘
		Serie		50.2
		Total		441.2
2. Serie Finale				
		1:	10.4	↓
		2:	10.4	←
		3:	10.8x	→
		4:	9.9	←
		5:	10.8x	←
		Serie		52.3
		Total		493.5

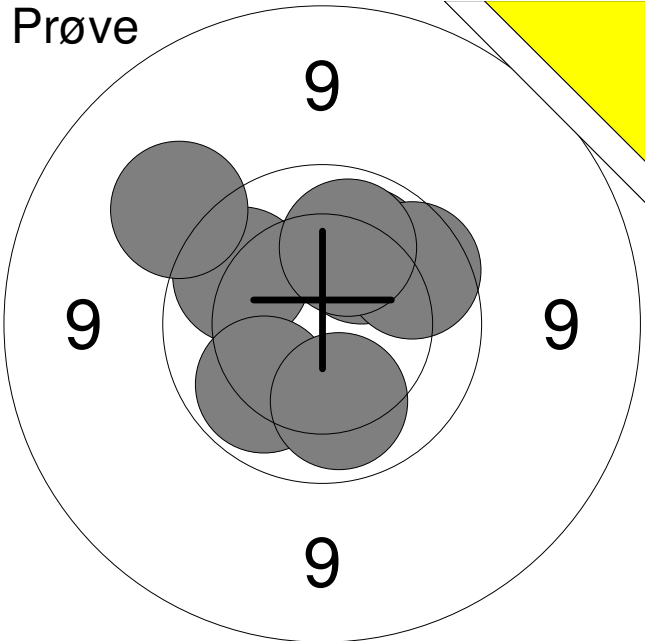
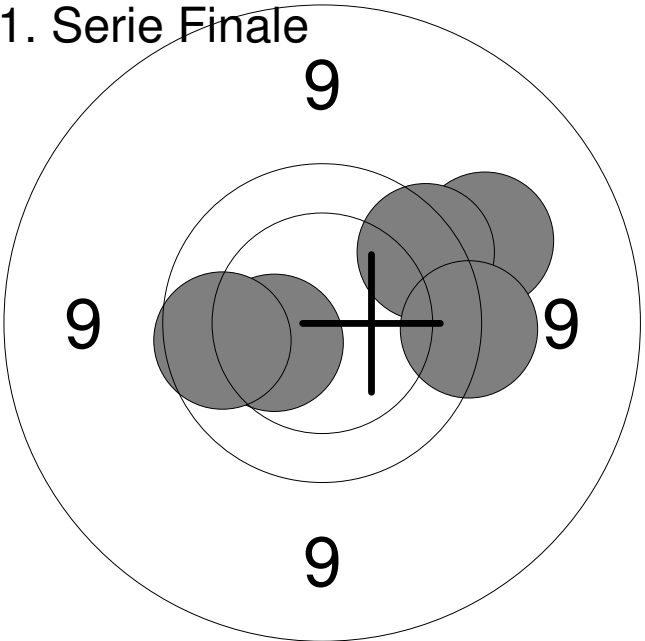
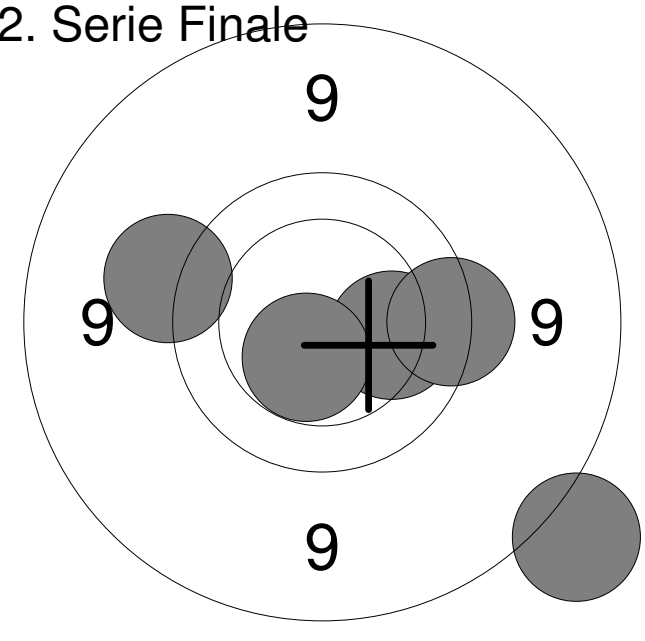
Hold 4	Skive 2	Morten Larsen		
Aalborg		Aalborg Skyttekreds		Stilling S
02.03.2018		Nordjysk mesterskab Finaler		Aalborg Skyttekreds
Prøve				
		1:	9.9	↖
		2:	10.0	↙
		3:	9.4	↗
		4:	10.1	↗
		5:	10.1	↘
		6:	9.9	↗
		7:	10.1	↗
		Serie		69.5
		Total		383.0
1. Serie Finale				
		1:	10.4	←
		2:	9.9	←
		3:	9.4	↗
		4:	9.7	↗
		5:	9.6	→
		Serie		49.0
		Total		432.0
2. Serie Finale				
		1:	8.5	↘
		2:	10.1	→
		3:	9.7	→
		4:	10.5x	↘
		5:	9.4	←
		Serie		48.2
		Total		480.2

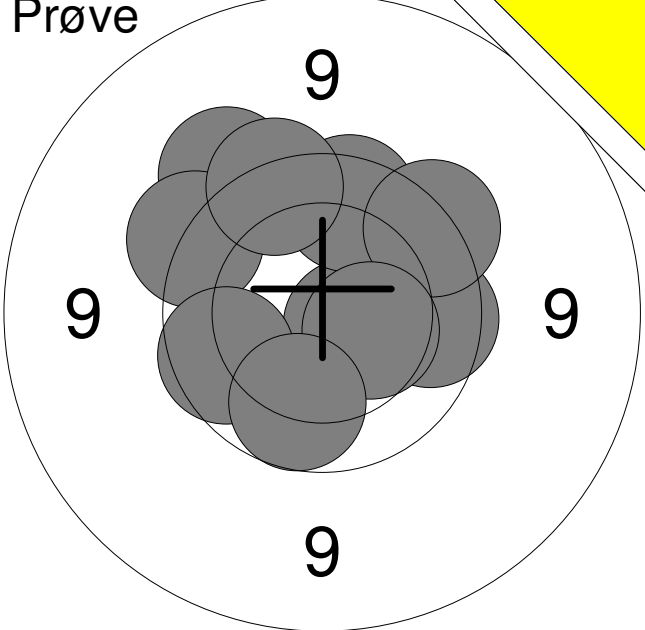
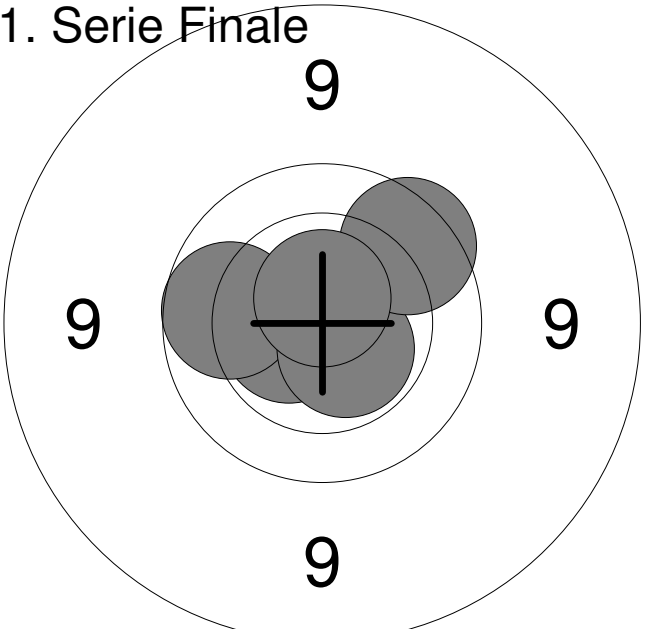
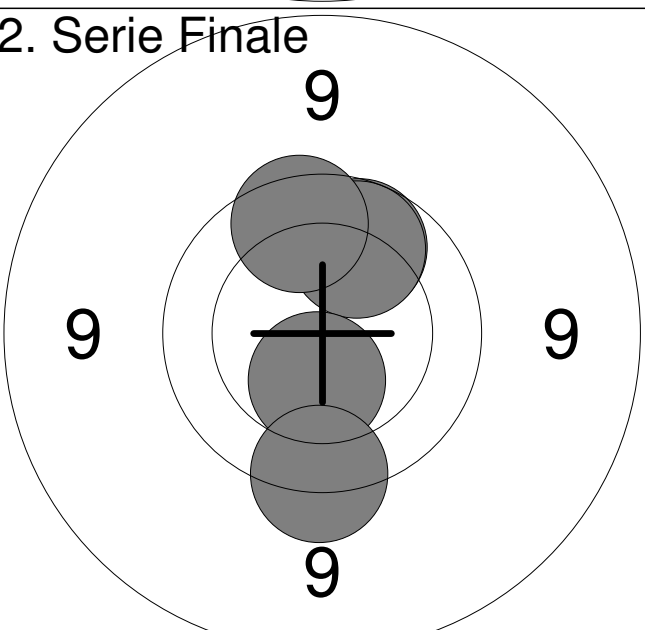
02.03.2018	Nordjysk mesterskab Finaler	Aalborg Skyttekreds																																			
Prøve 	<table style="width:100%; border-collapse: collapse;"> <tr><td>1:</td><td style="text-align: right;">9.8</td><td style="text-align: right;">→</td></tr> <tr><td>2:</td><td style="text-align: right;">10.6x</td><td style="text-align: right;">↘</td></tr> <tr><td>3:</td><td style="text-align: right;">9.8</td><td style="text-align: right;">↑</td></tr> <tr><td>4:</td><td style="text-align: right;">9.5</td><td style="text-align: right;">↗</td></tr> <tr><td>5:</td><td style="text-align: right;">9.6</td><td style="text-align: right;">↖</td></tr> <tr><td>6:</td><td style="text-align: right;">9.6</td><td style="text-align: right;">↗</td></tr> <tr><td>7:</td><td style="text-align: right;">10.4</td><td style="text-align: right;">→</td></tr> <tr><td>8:</td><td style="text-align: right;">9.9</td><td style="text-align: right;">←</td></tr> <tr><td>9:</td><td style="text-align: right;">9.7</td><td style="text-align: right;">↑</td></tr> <tr><td>10:</td><td style="text-align: right;">9.9</td><td style="text-align: right;">↓</td></tr> <tr><td colspan="2">Serie</td><td style="text-align: right;">98.8</td></tr> <tr><td colspan="2">Total</td><td style="text-align: right;">381.0</td></tr> </table>	1:	9.8	→	2:	10.6x	↘	3:	9.8	↑	4:	9.5	↗	5:	9.6	↖	6:	9.6	↗	7:	10.4	→	8:	9.9	←	9:	9.7	↑	10:	9.9	↓	Serie		98.8	Total		381.0
1:	9.8	→																																			
2:	10.6x	↘																																			
3:	9.8	↑																																			
4:	9.5	↗																																			
5:	9.6	↖																																			
6:	9.6	↗																																			
7:	10.4	→																																			
8:	9.9	←																																			
9:	9.7	↑																																			
10:	9.9	↓																																			
Serie		98.8																																			
Total		381.0																																			
1. Serie Finale 	<table style="width:100%; border-collapse: collapse;"> <tr><td>1:</td><td style="text-align: right;">10.6x</td><td style="text-align: right;">←</td></tr> <tr><td>2:</td><td style="text-align: right;">9.9</td><td style="text-align: right;">←</td></tr> <tr><td>3:</td><td style="text-align: right;">10.6x</td><td style="text-align: right;">↘</td></tr> <tr><td>4:</td><td style="text-align: right;">9.8</td><td style="text-align: right;">↗</td></tr> <tr><td>5:</td><td style="text-align: right;">10.7x</td><td style="text-align: right;">↑</td></tr> <tr><td colspan="2">Serie</td><td style="text-align: right;">51.6</td></tr> <tr><td colspan="2">Total</td><td style="text-align: right;">432.6</td></tr> </table>	1:	10.6x	←	2:	9.9	←	3:	10.6x	↘	4:	9.8	↗	5:	10.7x	↑	Serie		51.6	Total		432.6															
1:	10.6x	←																																			
2:	9.9	←																																			
3:	10.6x	↘																																			
4:	9.8	↗																																			
5:	10.7x	↑																																			
Serie		51.6																																			
Total		432.6																																			
2. Serie Finale 	<table style="width:100%; border-collapse: collapse;"> <tr><td>1:</td><td style="text-align: right;">9.9</td><td style="text-align: right;">↗</td></tr> <tr><td>2:</td><td style="text-align: right;">9.9</td><td style="text-align: right;">↗</td></tr> <tr><td>3:</td><td style="text-align: right;">10.4</td><td style="text-align: right;">↓</td></tr> <tr><td>4:</td><td style="text-align: right;">9.8</td><td style="text-align: right;">↑</td></tr> <tr><td>5:</td><td style="text-align: right;">9.6</td><td style="text-align: right;">↓</td></tr> <tr><td colspan="2">Serie</td><td style="text-align: right;">49.6</td></tr> <tr><td colspan="2">Total</td><td style="text-align: right;">482.2</td></tr> </table>	1:	9.9	↗	2:	9.9	↗	3:	10.4	↓	4:	9.8	↑	5:	9.6	↓	Serie		49.6	Total		482.2															
1:	9.9	↗																																			
2:	9.9	↗																																			
3:	10.4	↓																																			
4:	9.8	↑																																			
5:	9.6	↓																																			
Serie		49.6																																			
Total		482.2																																			

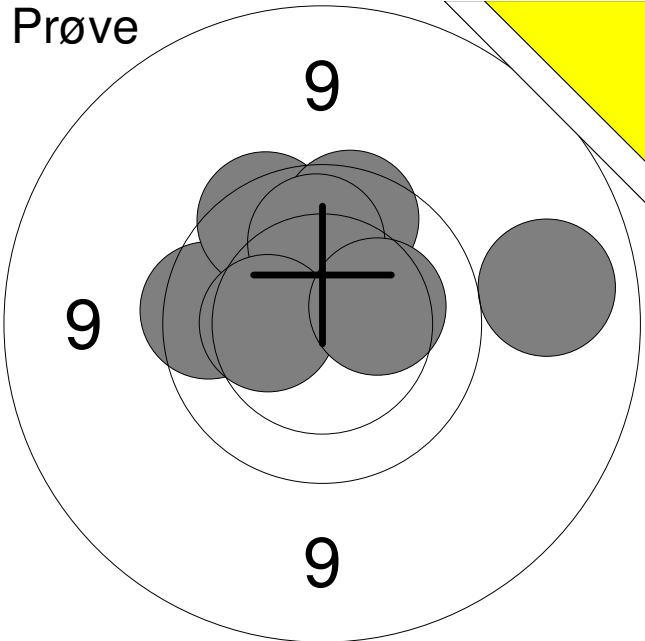
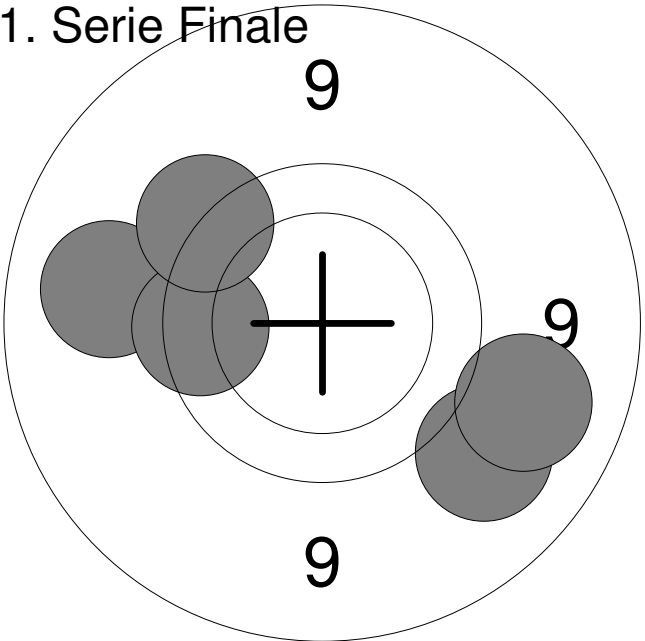
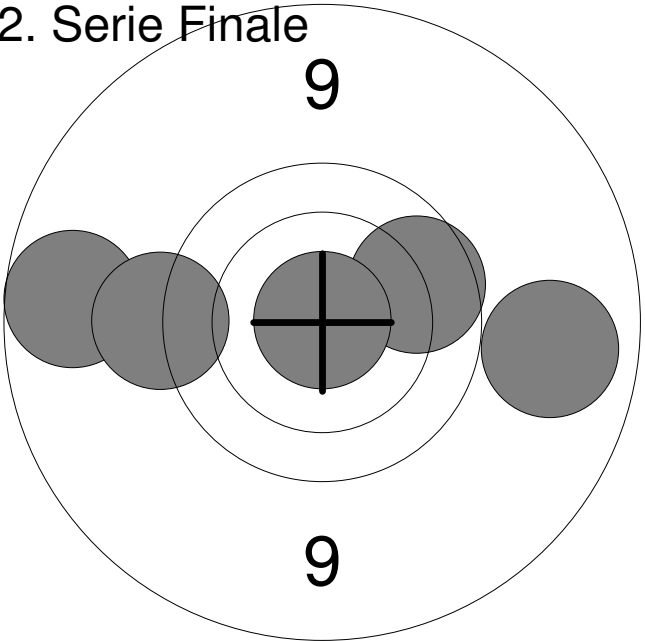
Hold 4	Skive 4	Annette Munkbøl		
Aalborg		Aalborg Skyttekreds		Stilling S
02.03.2018		Nordjysk mesterskab Finaler		Aalborg Skyttekreds
Prøve				
		1:	9.8	←
		2:	9.1	→
		3:	9.8	↖
		4:	9.8	↑
		5:	10.0	↑
		6:	10.4	←
		7:	10.3	→
		Serie		69.2
		Total		379.0
1. Serie Finale				
		1:	9.2	←
		2:	9.2	↘
		3:	9.8	←
		4:	9.6	↗
		5:	9.2	↘
		Serie		47.0
		Total		426.0
2. Serie Finale				
		1:	8.9	←
		2:	9.5	←
		3:	9.1	→
		4:	9.9	↗
		5:	10.9x	↑
		Serie		48.3
		Total		474.3

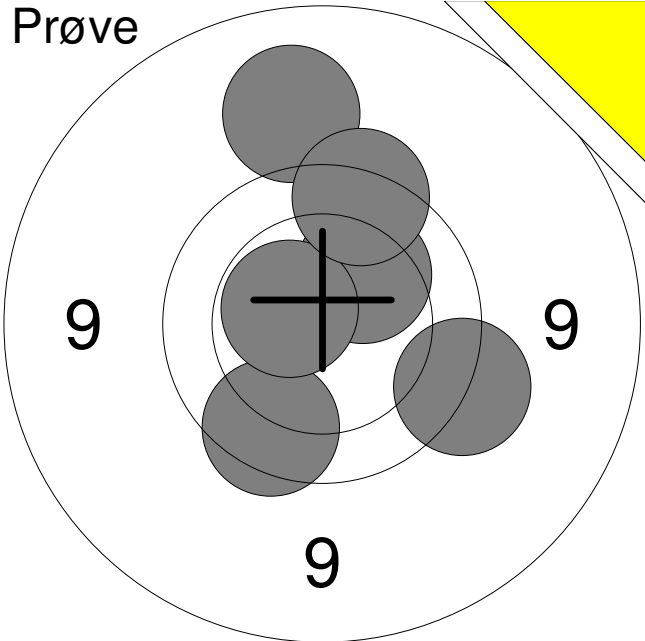
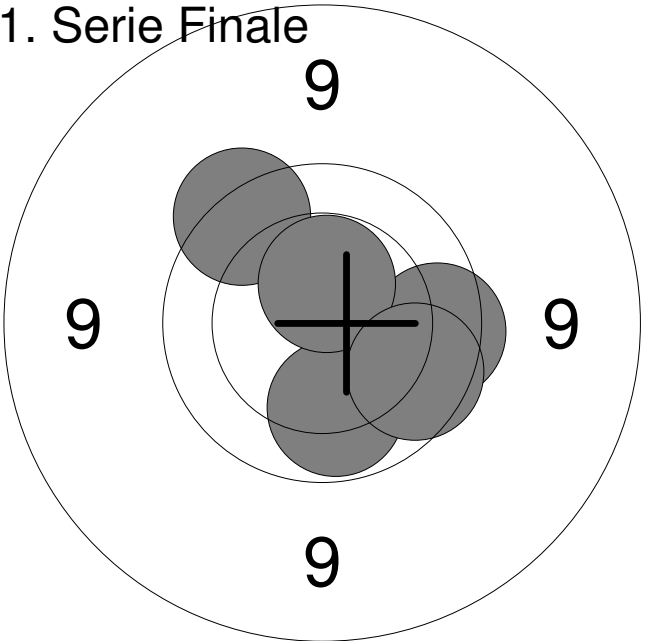
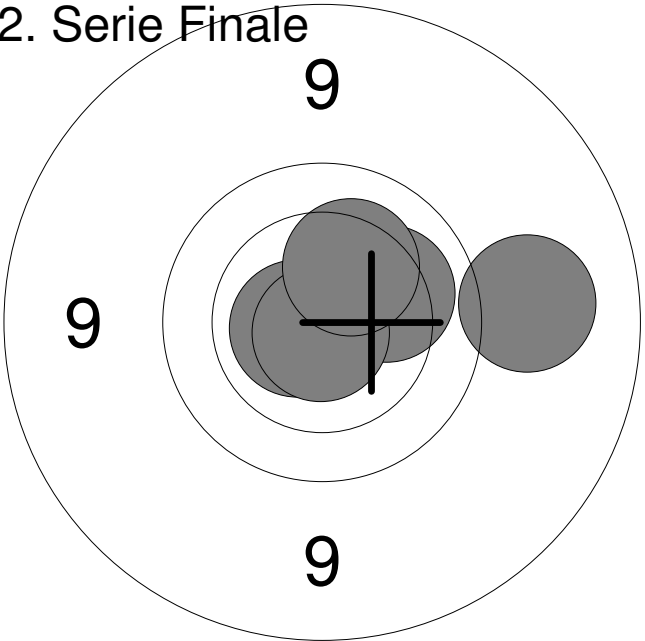
Hold 4	Skive 5	Stefan Olsen		
Aalborg		Aalborg Skyttekreds		Stilling S
02.03.2018		Nordjysk mesterskab Finaler		Aalborg Skyttekreds
Prøve				
		1:	9.6	→
		2:	9.8	↓
		3:	10.2	↗
		4:	9.2	↑
		5:	10.6x	↖
		6:	9.7	↑
		Serie		59.1
		Total		374.0
1. Serie Finale				
		1:	10.0	↓
		2:	9.8	→
		3:	9.7	↗
		4:	10.5x	↑
		5:	9.9	↘
		Serie		49.9
		Total		423.9
2. Serie Finale				
		1:	10.7x	←
		2:	9.2	→
		3:	10.2	↗
		4:	10.8x	↓
		5:	10.3	↗
		Serie		51.2
		Total		475.1

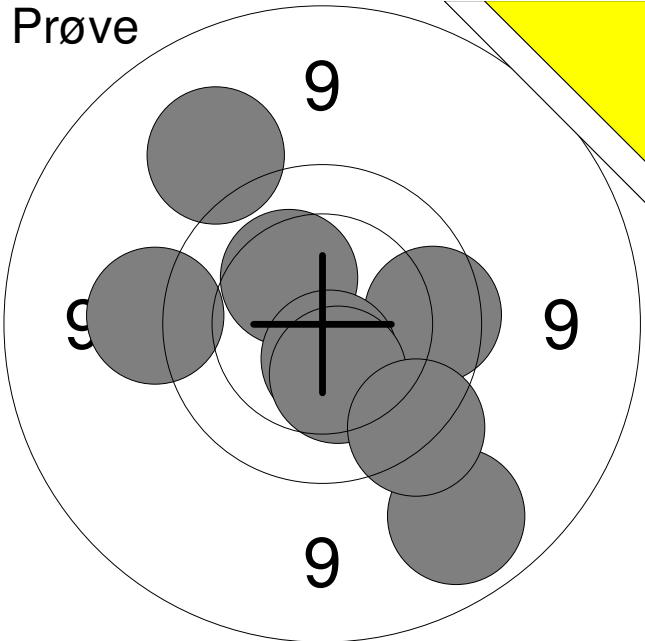
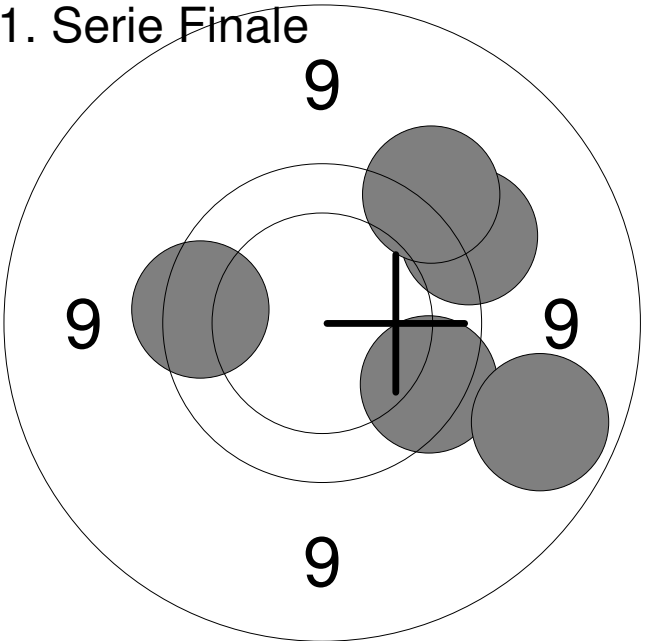
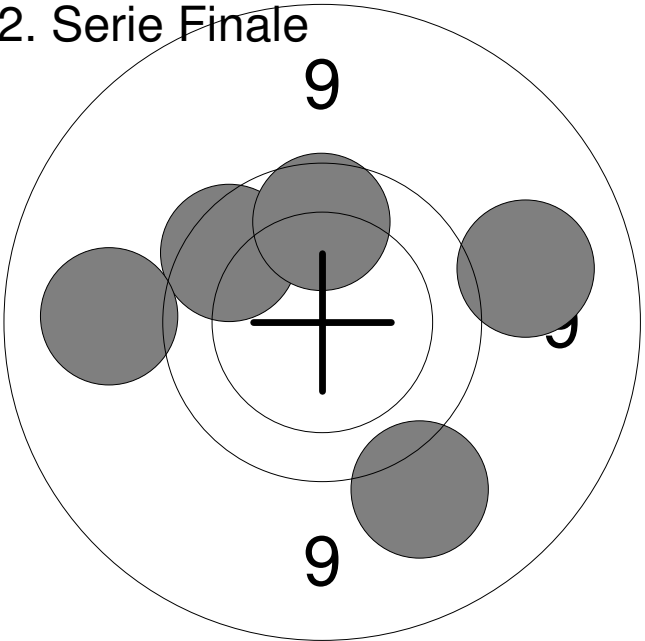
Hold 4	Skive 9	Anders Hansen		
Aalborg		Aalborg Skyttekreds		Stilling S
02.03.2018		Nordjysk mesterskab Finaler		Aalborg Skyttekreds
Prøve				
		1:	9.3	↗
		2:	9.8	→
		3:	9.0	↘
		4:	10.3	↗
		5:	10.6x	↘
		6:	10.4	↘
		7:	9.6	↘
		8:	9.5	←
		Serie		78.5
		Total		370.0
1. Serie Finale				
		1:	9.7	↘
		2:	9.0	↘
		3:	9.4	↗
		4:	9.5	↗
		5:	9.7	←
		Serie		47.3
		Total		417.3
2. Serie Finale				
		1:	9.2	→
		2:	9.3	↘
		3:	9.8	↗
		4:	9.2	←
		5:	9.9	↑
		Serie		47.4
		Total		464.7

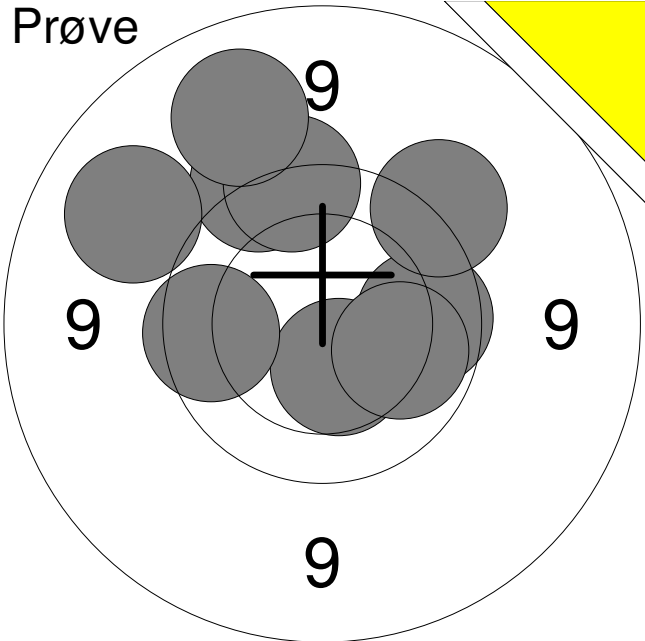
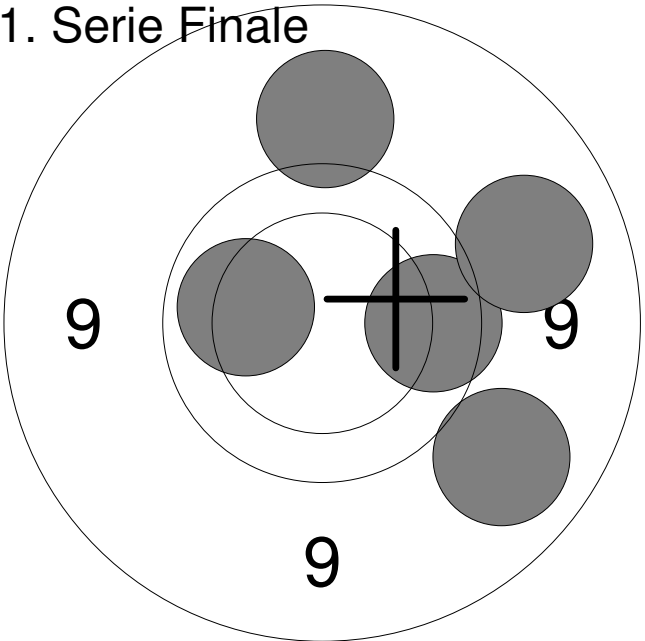
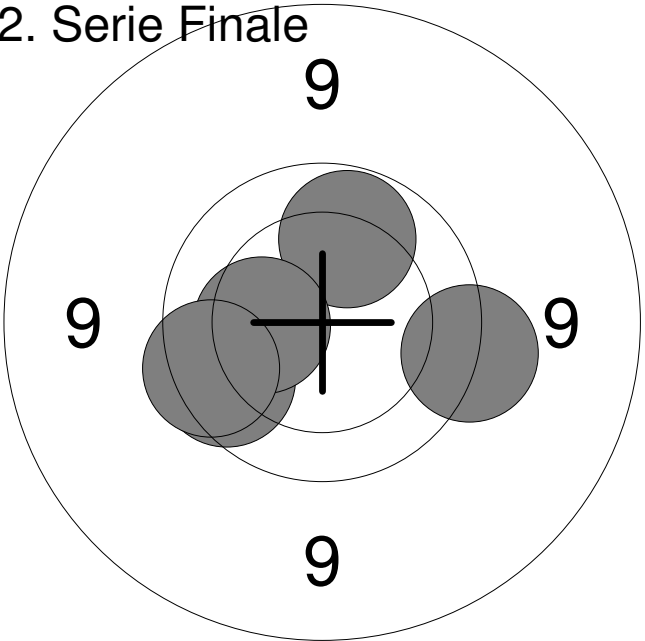
Hold 4	Skive 10	Sofie Frantsen		
Aalborg		Karby Skyttekreds		Stilling S
02.03.2018		Nordjysk mesterskab Finaler		Aalborg Skyttekreds
Prøve 		1: 9.9 → 2: 10.4 ↓ 3: 9.5 ↗ 4: 10.0 → 5: 9.6 ↑ 6: 9.1 ↗ 7: 9.5 ↗ 8: 9.8 ← 9: 9.1 ↗		
		Serie		86.9
		Total		370.0
1. Serie Finale 		1: 9.2 ↑ 2: 10.1 ← 3: 9.8 → 4: 9.1 ↓ 5: 9.2 ↗		
		Serie		47.4
		Total		417.4
2. Serie Finale 		1: 9.8 ↙ 2: 10.0 ↑ 3: 9.6 → 4: 10.3 ← 5: 9.8 ↙		
		Serie		49.5
		Total		466.9

<p>Prøve</p>	<table style="width:100%; border-collapse: collapse;"> <tr><td style="width:10%;">1:</td><td style="width:80%;">10.7x</td><td style="width:10%; text-align: right;">→</td></tr> <tr><td>2:</td><td>9.8</td><td style="text-align: right;">↙</td></tr> <tr><td>3:</td><td>9.5</td><td style="text-align: right;">↓</td></tr> <tr><td>4:</td><td>8.6</td><td style="text-align: right;">←</td></tr> <tr><td>5:</td><td>10.2</td><td style="text-align: right;">↗</td></tr> <tr><td>6:</td><td>9.4</td><td style="text-align: right;">↗</td></tr> <tr><td>7:</td><td>10.8x</td><td style="text-align: right;">↓</td></tr> <tr><td>8:</td><td>9.7</td><td style="text-align: right;">↗</td></tr> </table>	1:	10.7x	→	2:	9.8	↙	3:	9.5	↓	4:	8.6	←	5:	10.2	↗	6:	9.4	↗	7:	10.8x	↓	8:	9.7	↗
1:	10.7x	→																							
2:	9.8	↙																							
3:	9.5	↓																							
4:	8.6	←																							
5:	10.2	↗																							
6:	9.4	↗																							
7:	10.8x	↓																							
8:	9.7	↗																							
<table style="width:100%; border-collapse: collapse;"> <tr> <td style="width:85%;">Serie</td> <td style="text-align: right;">78.7</td> </tr> </table>		Serie	78.7																						
Serie	78.7																								
<table style="width:100%; border-collapse: collapse;"> <tr> <td style="width:85%;">Total</td> <td style="text-align: right;">369.0</td> </tr> </table>		Total	369.0																						
Total	369.0																								

<p>1. Serie Finale</p>	<table style="width:100%; border-collapse: collapse;"> <tr><td style="width:10%;">1:</td><td style="width:80%;">10.1</td><td style="width:10%; text-align: right;">↗</td></tr> <tr><td>2:</td><td>9.7</td><td style="text-align: right;">→</td></tr> <tr><td>3:</td><td>10.9x</td><td style="text-align: right;">↓</td></tr> <tr><td>4:</td><td>9.7</td><td style="text-align: right;">↗</td></tr> <tr><td>5:</td><td>9.2</td><td style="text-align: right;">←</td></tr> </table>	1:	10.1	↗	2:	9.7	→	3:	10.9x	↓	4:	9.7	↗	5:	9.2	←
1:	10.1	↗														
2:	9.7	→														
3:	10.9x	↓														
4:	9.7	↗														
5:	9.2	←														
<table style="width:100%; border-collapse: collapse;"> <tr> <td style="width:85%;">Serie</td> <td style="text-align: right;">49.6</td> </tr> </table>		Serie	49.6													
Serie	49.6															
<table style="width:100%; border-collapse: collapse;"> <tr> <td style="width:85%;">Total</td> <td style="text-align: right;">418.6</td> </tr> </table>		Total	418.6													
Total	418.6															

<p>2. Serie Finale</p>	<table style="width:100%; border-collapse: collapse;"> <tr><td style="width:10%;">1:</td><td style="width:80%;">10.0</td><td style="width:10%; text-align: right;">↗</td></tr> <tr><td>2:</td><td>10.0</td><td style="text-align: right;">→</td></tr> <tr><td>3:</td><td>9.7</td><td style="text-align: right;">↗</td></tr> <tr><td>4:</td><td>9.3</td><td style="text-align: right;">←</td></tr> <tr><td>5:</td><td>10.0</td><td style="text-align: right;">→</td></tr> </table>	1:	10.0	↗	2:	10.0	→	3:	9.7	↗	4:	9.3	←	5:	10.0	→
1:	10.0	↗														
2:	10.0	→														
3:	9.7	↗														
4:	9.3	←														
5:	10.0	→														
<table style="width:100%; border-collapse: collapse;"> <tr> <td style="width:85%;">Serie</td> <td style="text-align: right;">49.0</td> </tr> </table>		Serie	49.0													
Serie	49.0															
<table style="width:100%; border-collapse: collapse;"> <tr> <td style="width:85%;">Total</td> <td style="text-align: right;">467.6</td> </tr> </table>		Total	467.6													
Total	467.6															

Prøve 	1:	10.3	→
	2:	9.8	↙
	3:	9.0	↘
	4:	9.4	↖
	5:	9.5	↘
	6:	8.6	↘
	7:	9.6	↘
	8:	9.9	→
	9:	9.3	←
	Serie		85.4
Total		369.0	

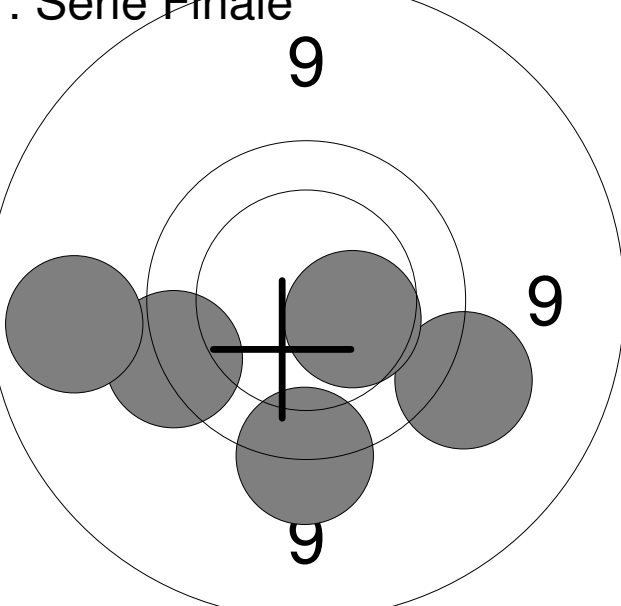
1. Serie Finale 	1:	9.5	↓
	2:	9.6	↖
	3:	9.1	↖
	4:	9.4	↘
	5:	10.4	↘
Serie		48.0	
Total		417.0	

2. Serie Finale 	1:	8.9	←
	2:	8.9	→
	3:	10.6x	↘
	4:	9.4	↖
	5:	9.9	↓
Serie		47.7	
Total		464.7	

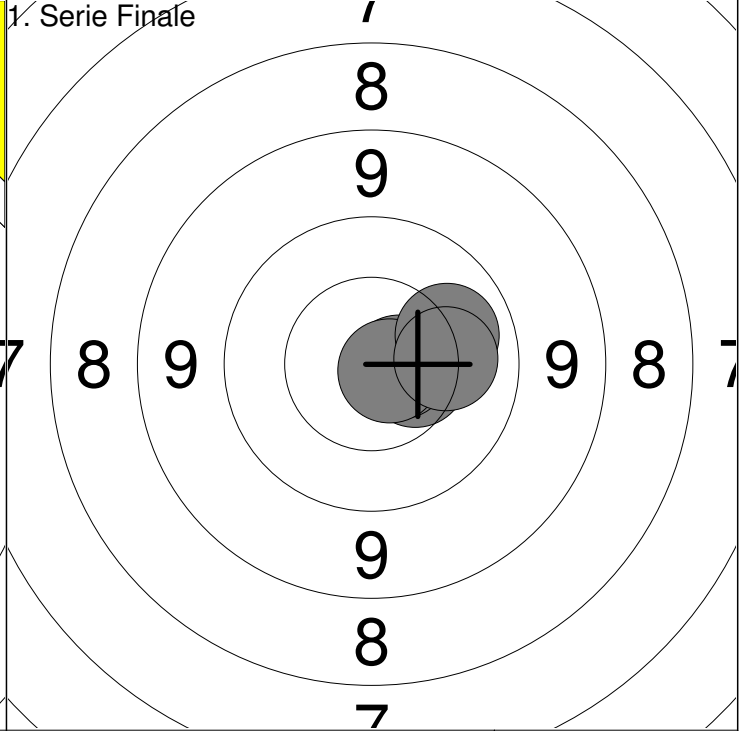
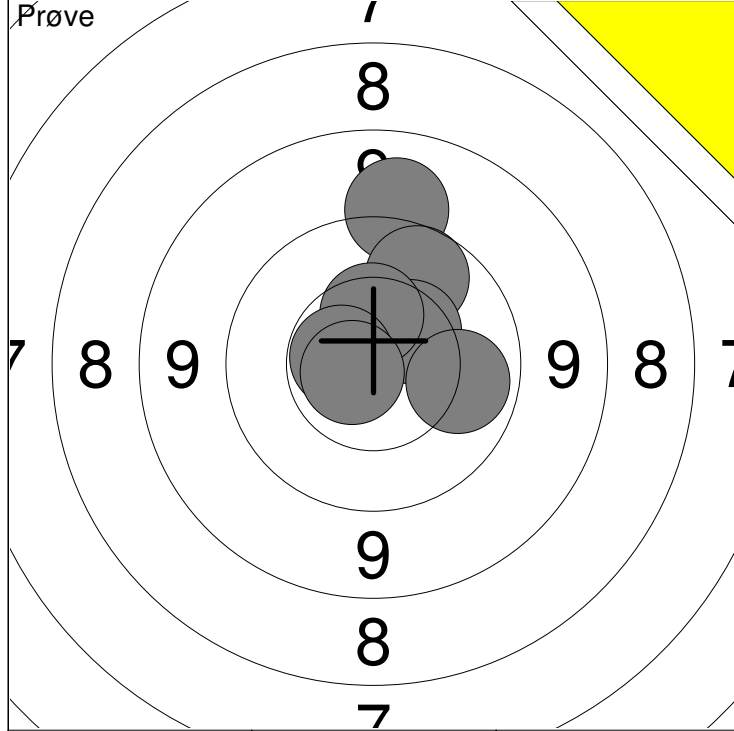

1: 9.3 ↑	6: 10.6x ←	Serie	71.3
2: 9.9 ↗	7: 10.7x ←		
3: 10.4 ↗		Total	400.0
4: 10.4 ↑			
5: 10.0 →			

1: 10.5 →	Serie	52.2
2: 10.7x →		
3: 10.7x →	Total	452.2
4: 10.1 →		
5: 10.2 →		

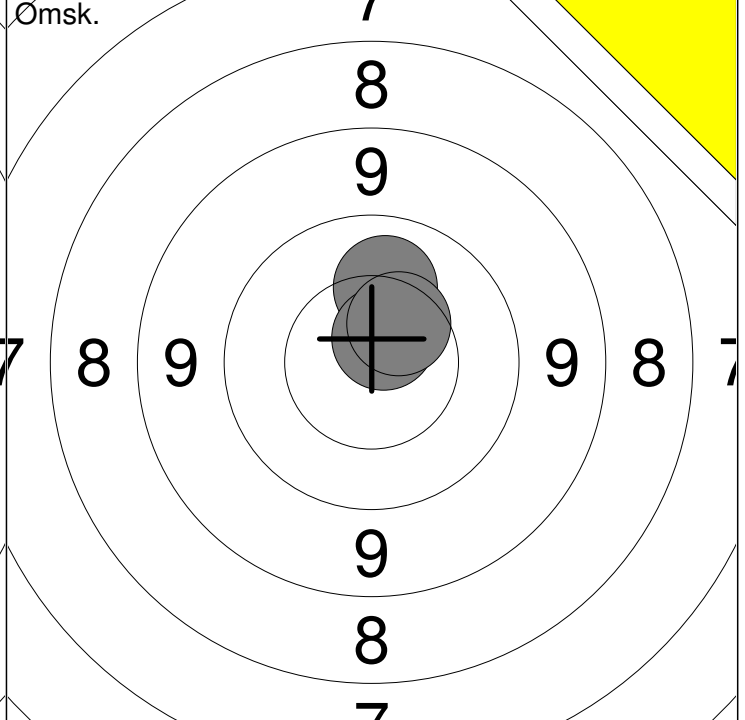
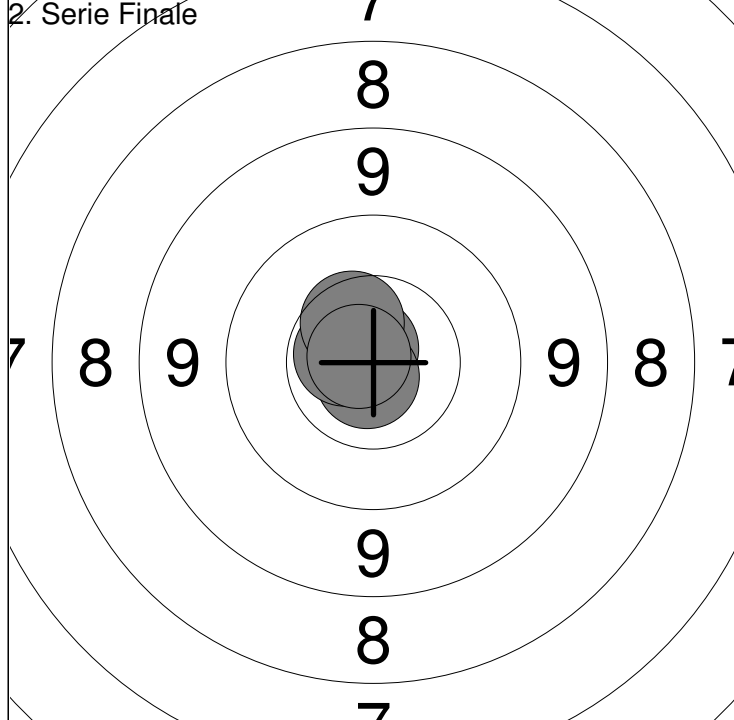

1: 10.8x ↗	Serie	53.5
2: 10.8x ↓		
3: 10.6x ←	Total	505.7
4: 10.5 ↗		
5: 10.8x ←		

1: 10.2 ↑	Serie	31.4
2: 10.7x ↗		
3: 10.5 ↗	Total	505.7

Hold 5	Skive 2	Isabella Bonde
------------------	-------------------	-----------------------

Aalborg	Vodskov Skytteforening	BK	L
---------	------------------------	----	---

02.03.2018	Nordjysk mesterskab Finaler	Aalborg Skyttekreds
------------	-----------------------------	---------------------

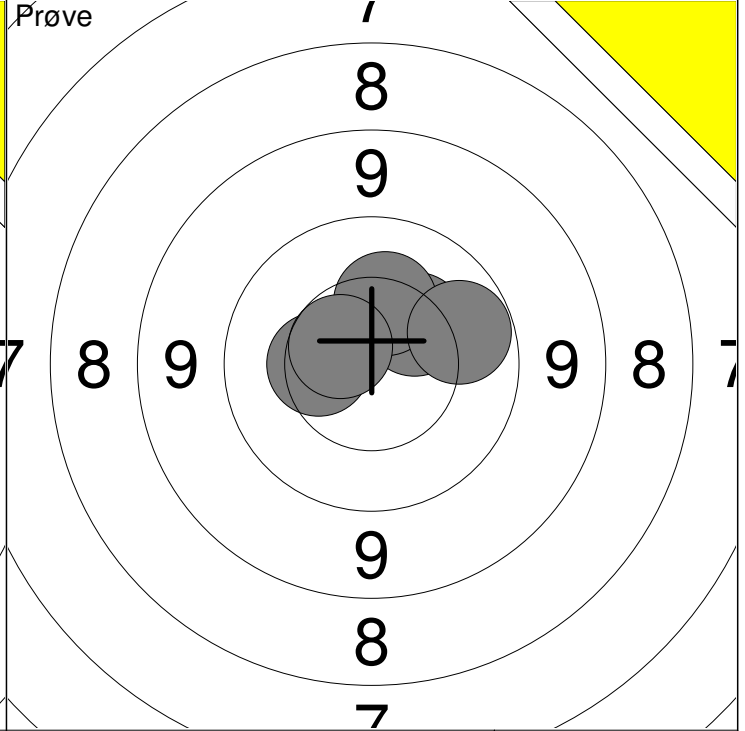
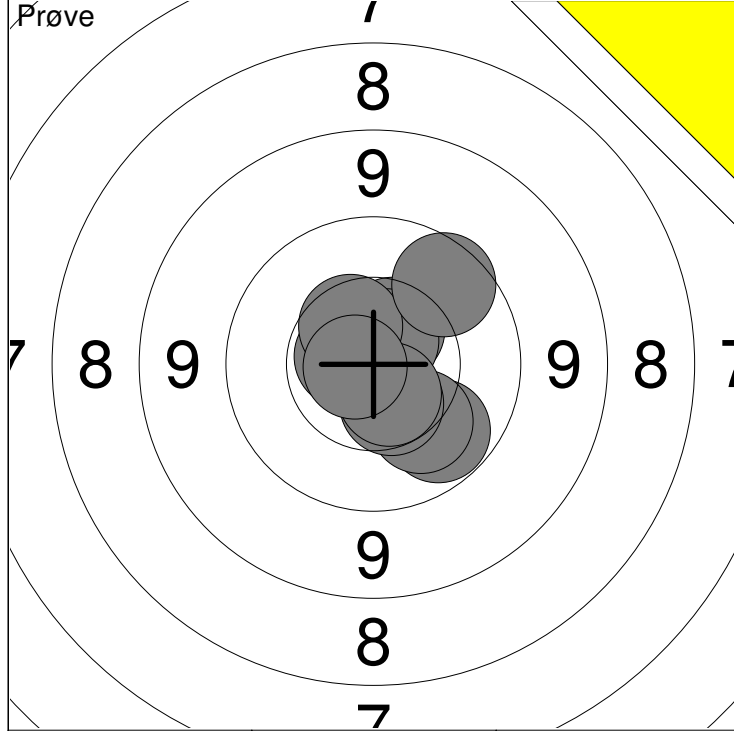

1: 10.0 ↘	6: 10.5 ↘	Serie 104.3
2: 10.5 ↗	7: 10.6x ↘	
3: 10.2 ↘	8: 10.5 ↗	Total 400.0
4: 10.7x ←	9: 10.8x ←	
5: 10.7x ↗	10: 9.8 ↗	

11: 10.3 ↗	Serie 51.6
12: 10.3 ↗	
13: 10.0 →	Total 400.0
14: 10.4 ←	
15: 10.6 ←	

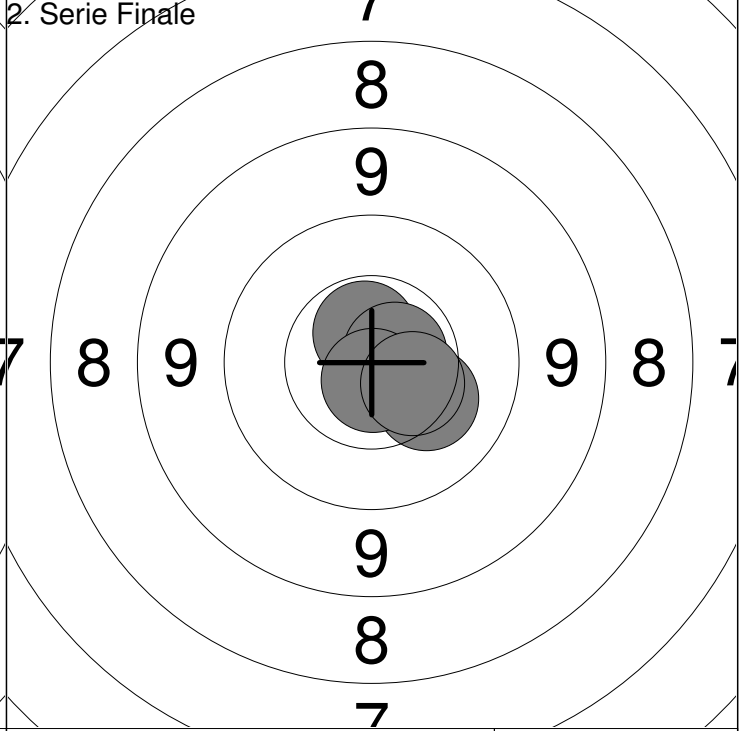
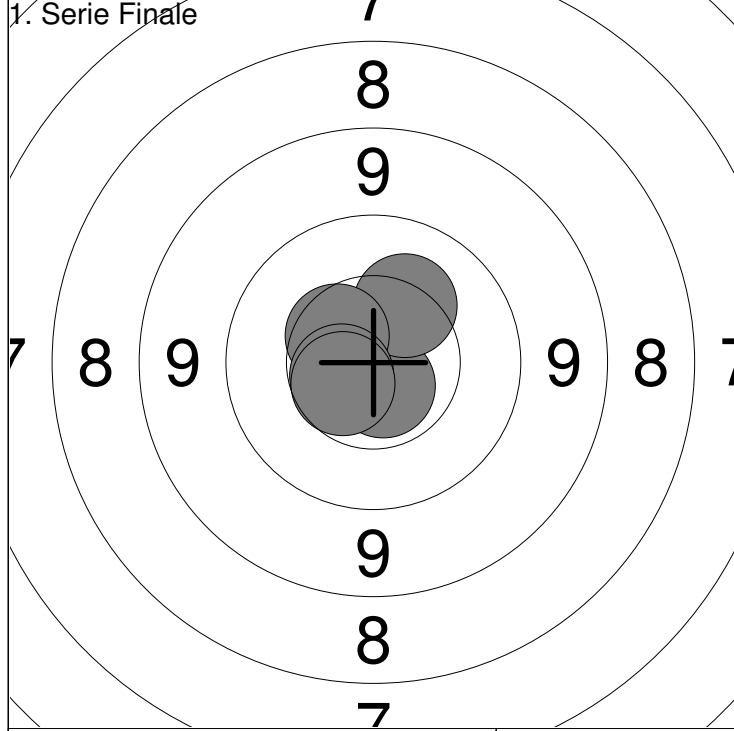

1: 10.7x ↘	Serie 52.7
2: 10.3 ↗	
3: 10.5 ↗	Total 452.7
4: 10.6x ←	
5: 10.6 ↘	

1: 10.6x ↗	Serie 52.9
2: 10.7x →	
3: 10.3 ↘	Total 505.6
4: 10.8x ↘	
5: 10.5 →	

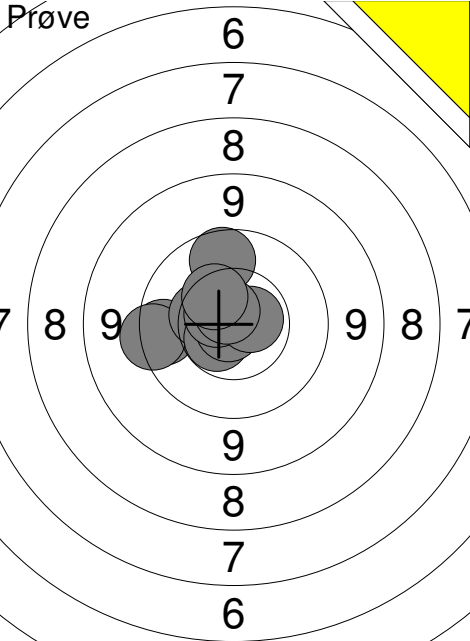
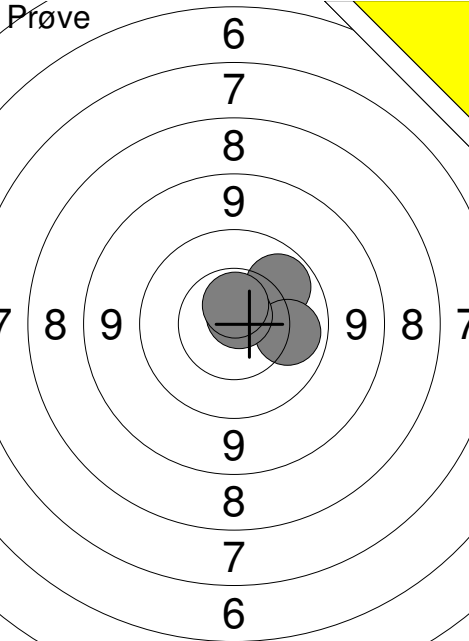
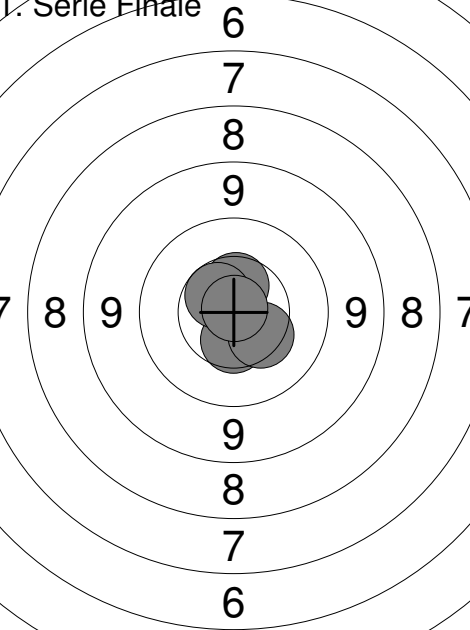
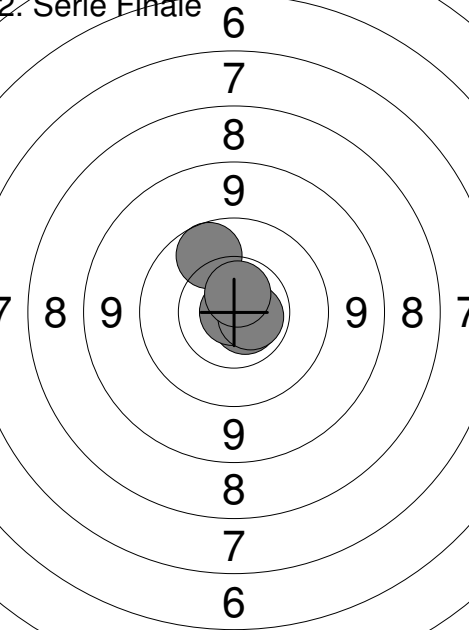
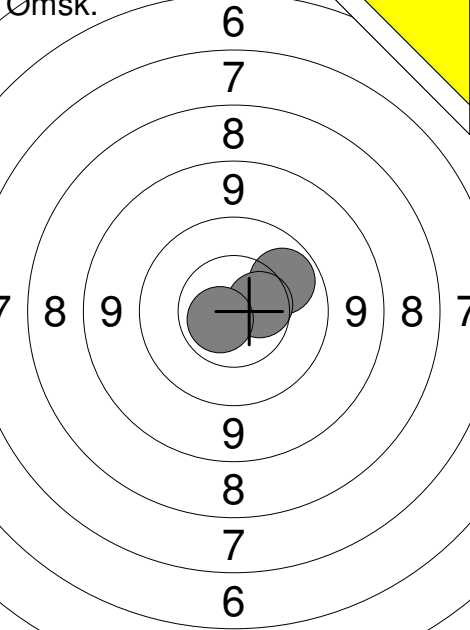
Hold 5	Skive 3	Nikolaj Gatten			
Aalborg		Løgstør Sportsskytteklub	BK L		
02.03.2018		Nordjysk mesterskab Finaler	Aalborg Skyttekreds		
Prøve		1: 9.8 ← 2: 9.6 ← 3: 10.4 ← 4: 10.6x ↙ 5: 10.8x ↙ 6: 10.6x ↖ 7: 9.9 ↑ 8: 10.7x → 9: 10.7x ↗ 10: 10.4 ↖	Prøve		11: 10.0 ↗ 12: 10.1 → 13: 10.8x ↗ 14: 10.6x ↑
		Serie 103.5		Serie 41.5	
		Total 400.0		Total 400.0	
1. Serie Finate		1: 10.5 ↓ 2: 10.4 ↘ 3: 10.5 ↑ 4: 10.6 ↖ 5: 10.9x ↑	2. Serie Finate		1: 9.9 ↖ 2: 10.7x ↘ 3: 10.9x ← 4: 10.7x → 5: 10.6x ↑
		Serie 52.9		Serie 52.8	
		Total 452.9		Total 505.7	
Ømsk.		1: 10.0 ↗ 2: 10.5 → 3: 10.7x ↙			
		Serie 31.2			
		Total 505.7			

Hold 5	Skive 4	Emil Hedemann
------------------	-------------------	----------------------

Aalborg	Vester Hassing Skytteforening	BK	L
---------	-------------------------------	----	---

02.03.2018	Nordjysk mesterskab Finaler	Aalborg Skyttekreds
------------	-----------------------------	---------------------

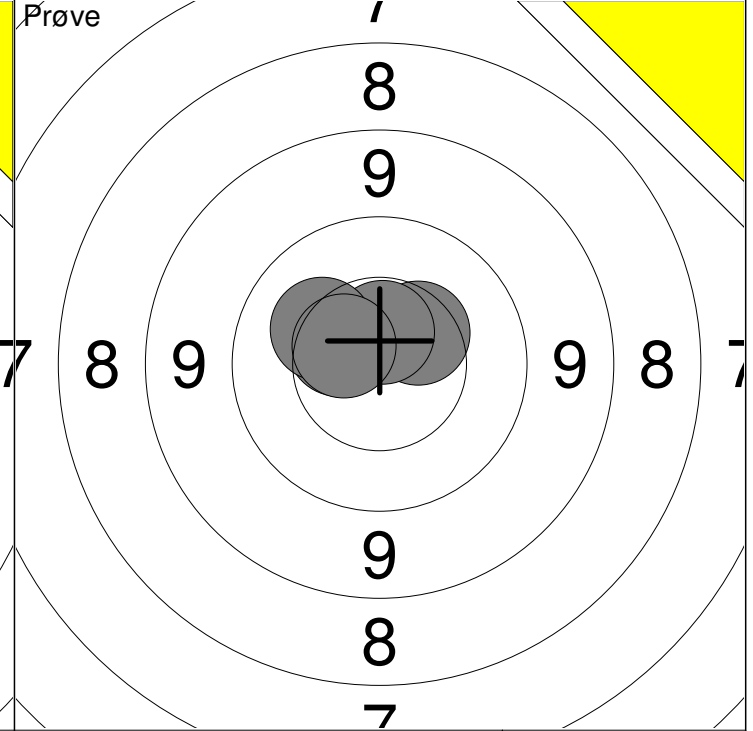
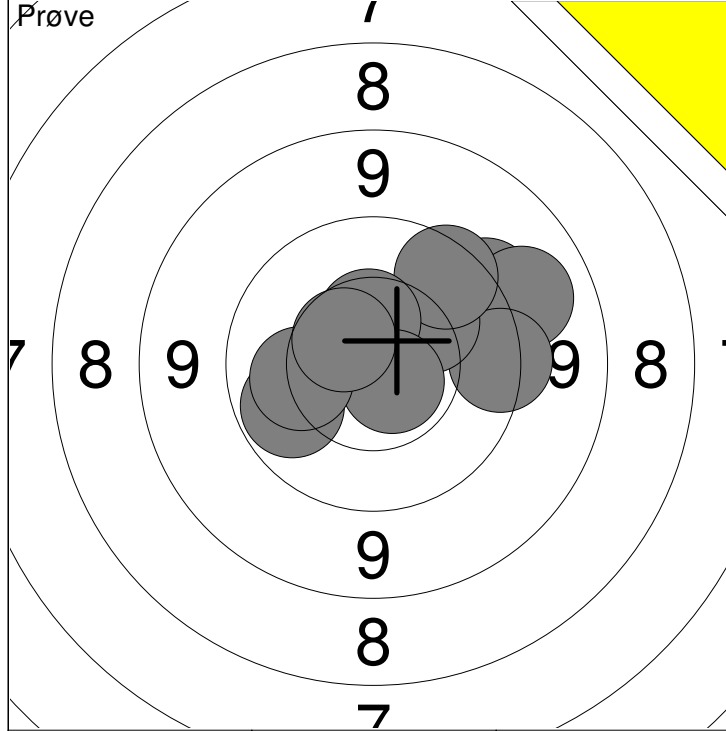

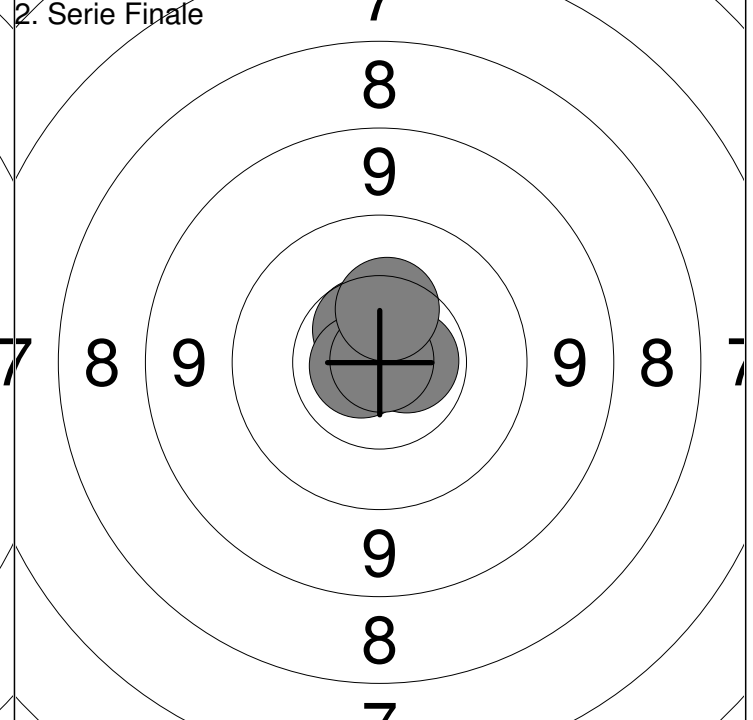
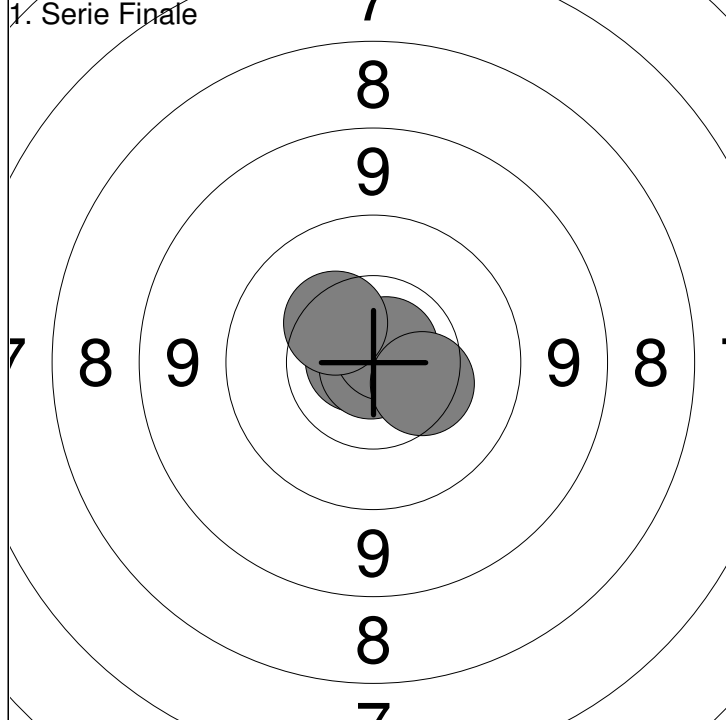

1: 9.5 ↗	6: 10.0 ←	Serie 100.2
2: 9.2 ↗	7: 10.5 ↑	
3: 9.6 →	8: 10.7x ↘	Total 400.0
4: 10.2 ↗	9: 10.2 ←	
5: 9.7 ↗	10: 10.6 ↖	

11: 10.4 ↗	Serie 52.2
12: 10.6x ↑	
13: 10.5 ↖	Total 400.0
14: 10.2 ↖	
15: 10.5 ↖	

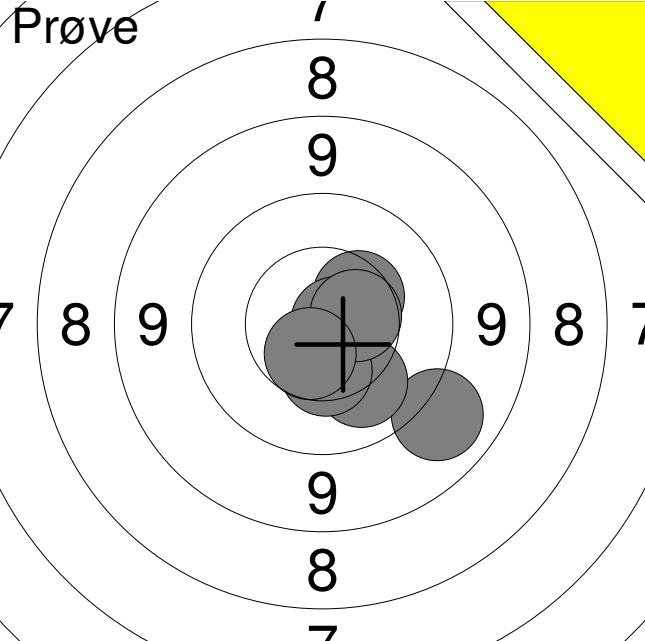
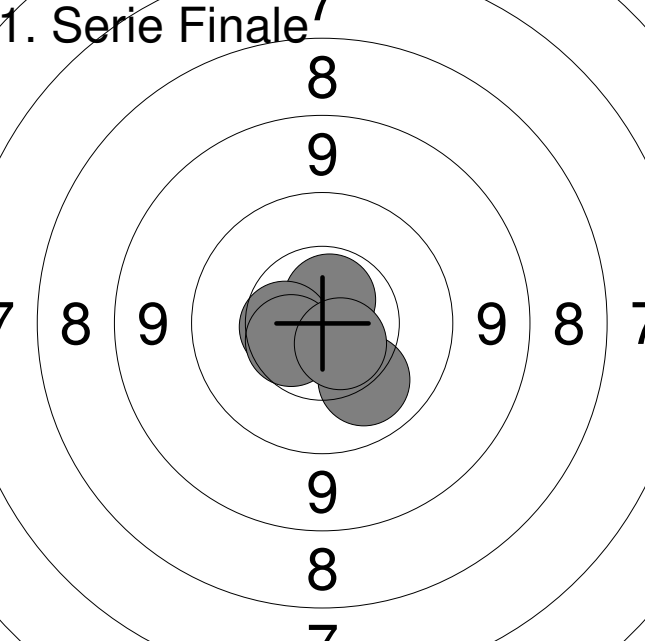

1: 10.8x ←	Serie 53.3
2: 10.9x ↘	
3: 10.8x ↗	Total 453.3
4: 10.4 →	
5: 10.4 ↖	

1: 10.6 ↖	Serie 53.4
2: 10.7x →	
3: 10.8x ←	Total 506.7
4: 10.9x ↗	
5: 10.4 ↑	

Hold 5	Skive 5	Magnus Johansen		
Aalborg		Boddum-Ydby Skytteforening		BK
02.03.2018		Nordjysk mesterskab Finaler		Aalborg Skyttekreds
Prøve				
		1:	10.4	↗
		2:	9.1	↘
		3:	10.1	↘
		4:	10.8x	→
		5:	10.4	↓
		6:	10.5	→
		7:	10.6	↓
		Serie		71.9
		Total		400.0
1. Serie Finale				
		1:	10.7x	↑
		2:	10.1	↘
		3:	10.5	←
		4:	10.5	←
		5:	10.6x	↘
		Serie		52.4
		Total		452.4
2. Serie Finale				
		1:	10.8x	↙
		2:	10.1	→
		3:	10.1	↑
		4:	10.6	↘
		5:	10.3	→
		Serie		51.9
		Total		504.3

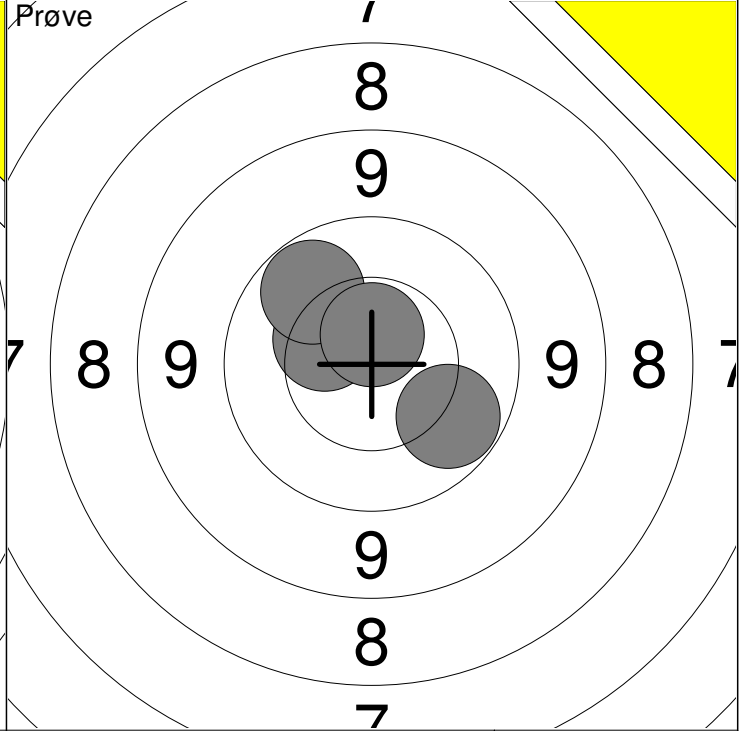
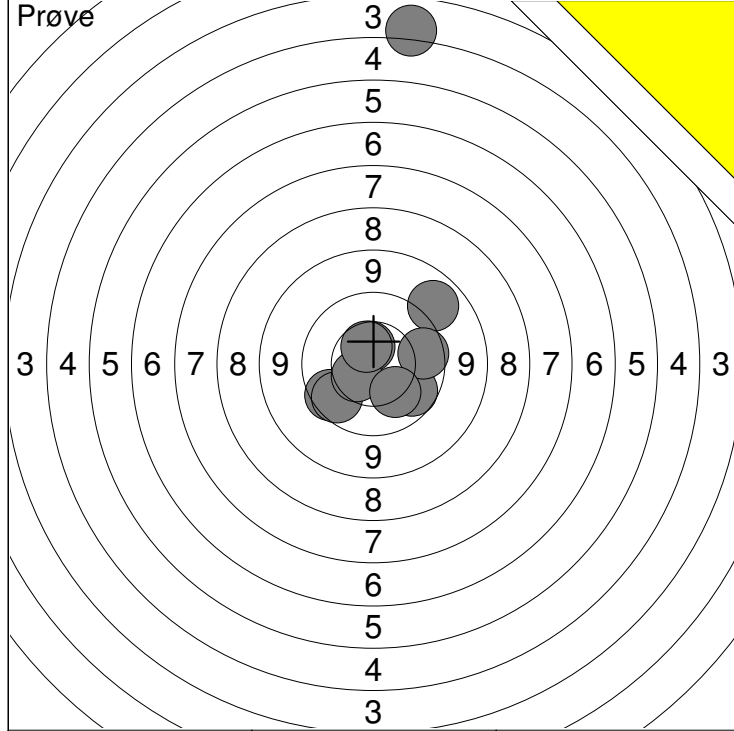

1: 3.1 ↑	6: 9.9 ↙	Serie 93.4
2: 9.1 ↗	7: 10.6 ↑	
3: 9.9 ↘	8: 10.5 ↙	Total 399.0
4: 9.8 →	9: 10.5 ↑	
5: 9.8 ↙	10: 10.2 ↘	

11: 10.0 ↘	Serie 41.0
12: 10.4 ↖	
13: 10.0 ↗	Total 399.0
14: 10.6x ↑	

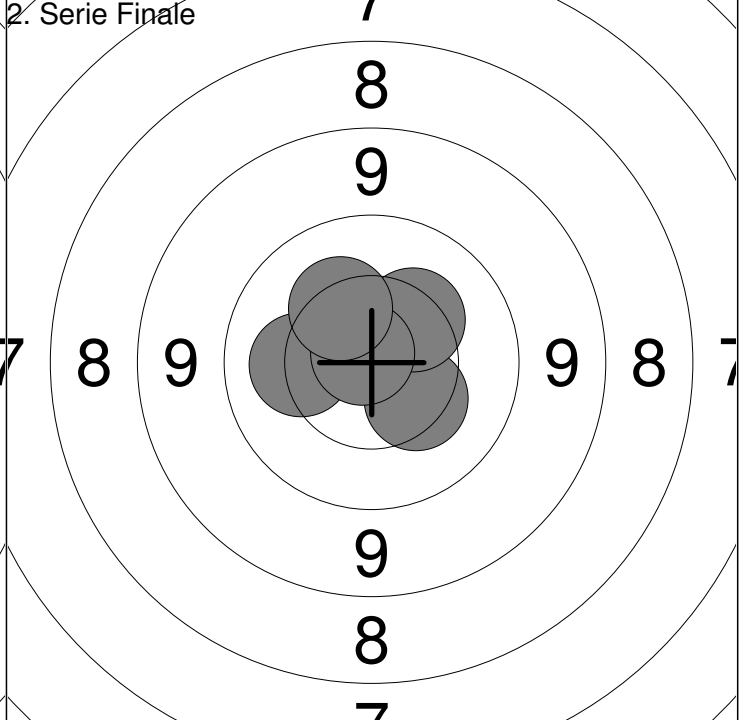
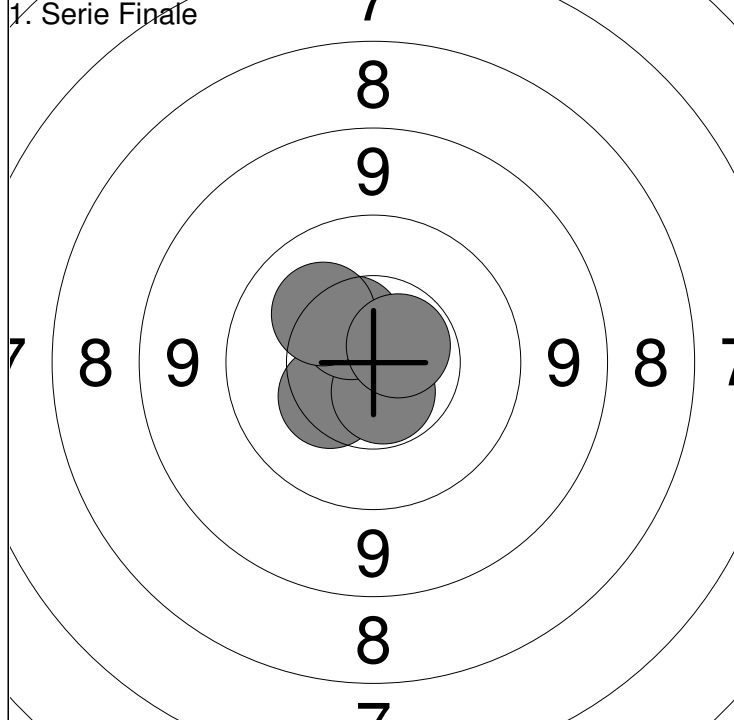

1: 10.4 ↙	Serie 52.3
2: 10.6x ↘	
3: 10.5 ↗	Total 451.3
4: 10.2 ↖	
5: 10.6x ↗	

1: 10.3 ↘	Serie 51.9
2: 10.3 ↗	
3: 10.2 ←	Total 503.2
4: 10.8x ↖	
5: 10.3 ↗	

Hold 5	Skive 7	Liva Møller		
Aalborg		Vilsted Skytteforening	BK	L
02.03.2018		Nordjysk mesterskab Finaler	Aalborg Skyttekreds	
Prøve			1: 10.3	→
			2: 10.2	↓
			3: 10.4	↙
			4: 10.9x	↓
			5: 10.6x	↓
			6: 10.4	←
			7: 10.7x	↑
			8: 10.7x	↘
			9: 10.4	↙
			10: 10.6x	←
			Serie	105.2
		Total	399.0	
1. Serie Finale			1: 10.4	↓
			2: 10.7x	↗
			3: 10.4	→
			4: 10.6x	↗
			5: 10.6x	←
			Serie	52.7
		Total	451.7	
2. Serie Finale			1: 10.7x	↑
			2: 10.4	↖
			3: 10.5	↙
			4: 10.5	↗
			5: 10.4	←
			Serie	52.5
		Total	504.2	

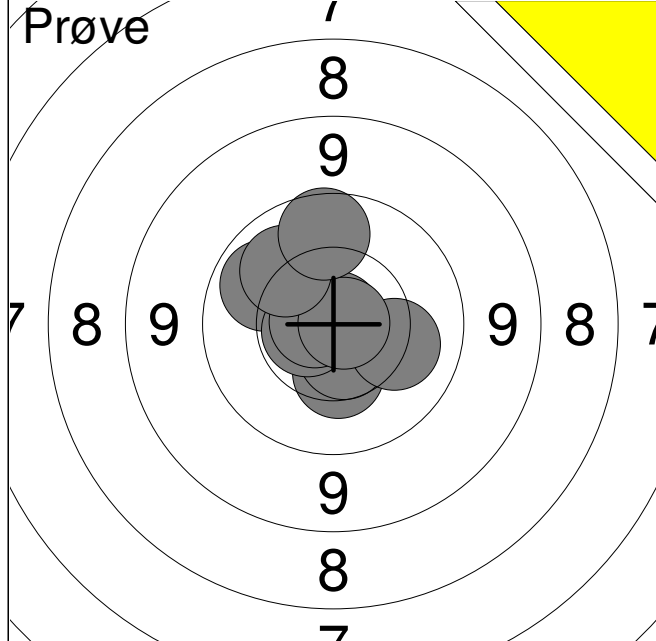

1:	10.4	↓
2:	10.6	↓
3:	10.2	→
4:	10.0	↖
5:	10.9x	↗
6:	10.6x	←
7:	10.7x	←
8:	10.8x	→
9:	10.1	↗
10:	9.9	↑
Serie		104.2
Total		399.0



1:	10.3	↗
2:	10.6	↓
3:	10.5	↖
4:	10.8x	↗
5:	10.2	→
Serie		52.4
Total		451.4

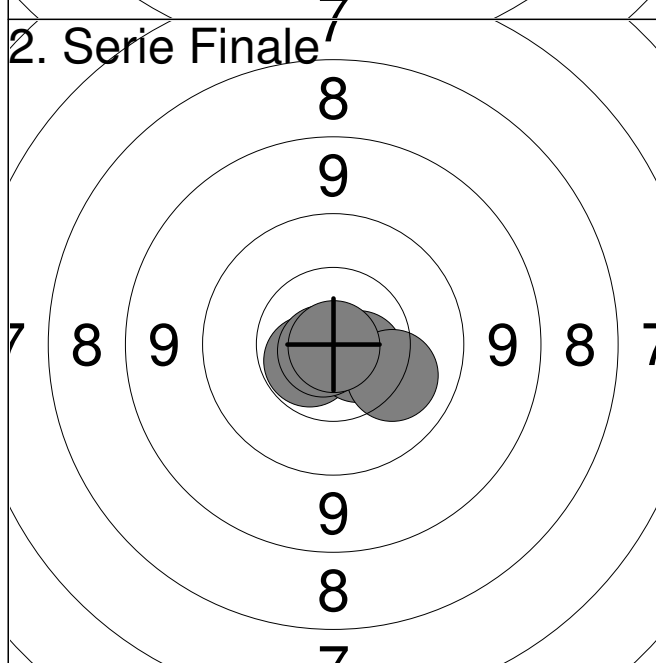

1:	10.6x	↖
2:	10.6x	→
3:	10.2	→
4:	10.8x	↖
5:	10.9x	↓
Serie		53.1
Total		504.5

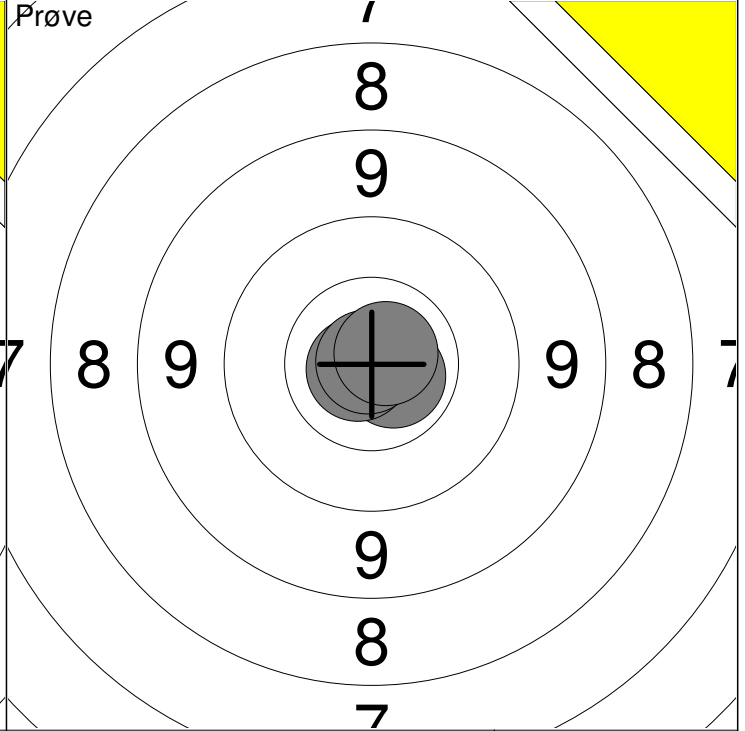
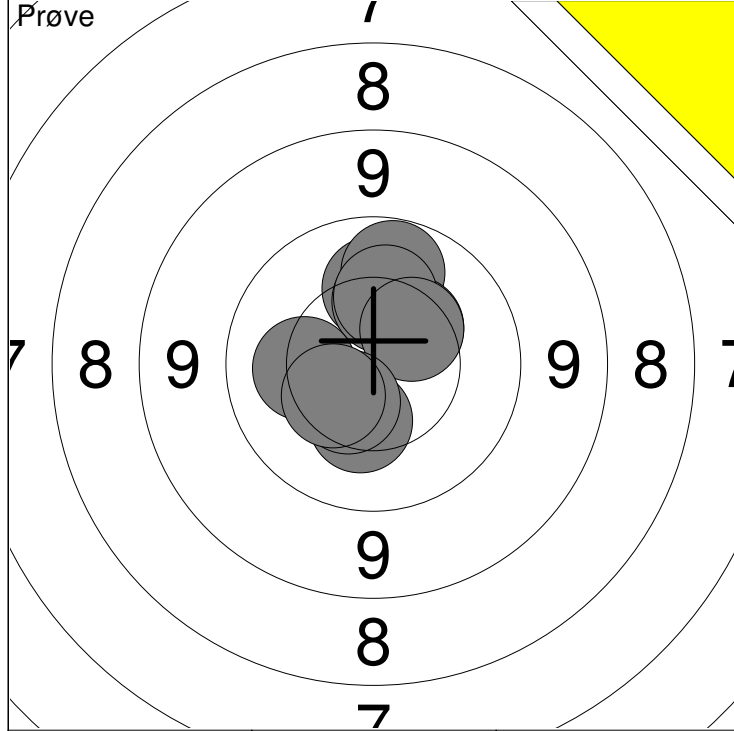



1: 10.2 ↑	6: 10.4 ↗	Serie 102.9
2: 10.3 ↑	7: 10.3 ↓	
3: 10.0 ↑	8: 10.2 ←	Total 399.0
4: 10.4 ↗	9: 10.5 ↓	
5: 10.2 ↑	10: 10.4 ↙	

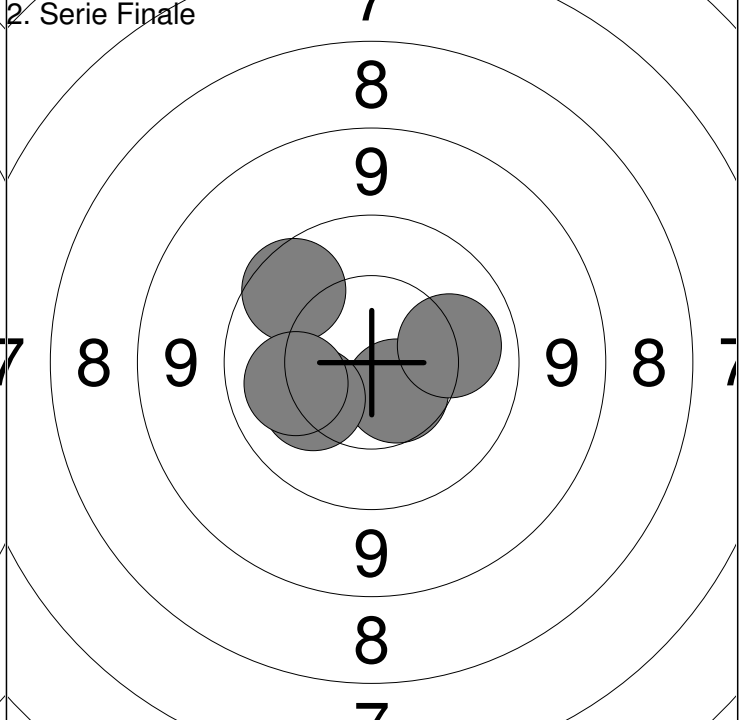
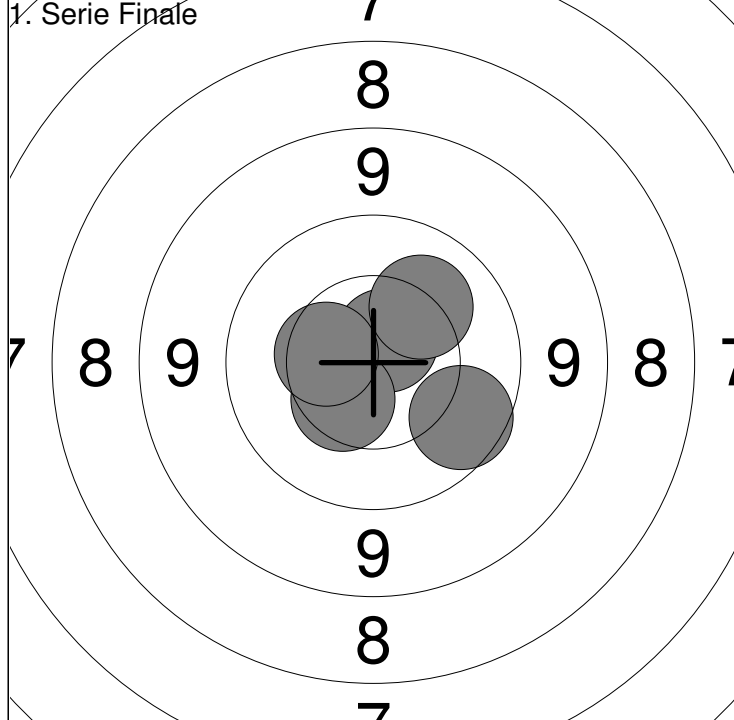

11: 10.7x ⇒	Serie 43.2
12: 10.8x ⇐	
13: 10.9x ↖	Total 399.0
14: 10.8x ↗	

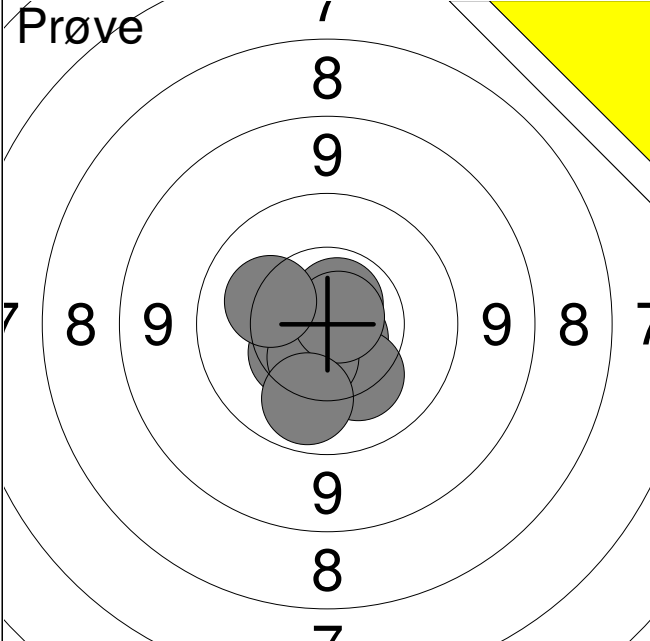
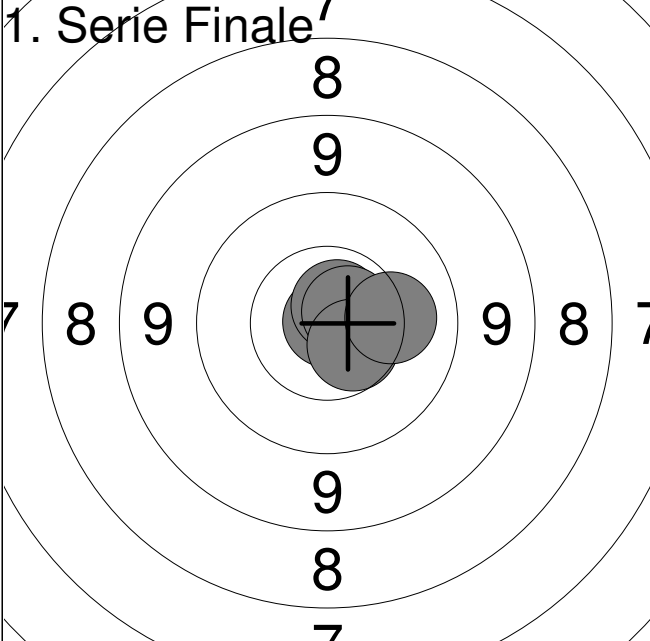

1: 10.7x ↗	Serie 51.7
2: 10.4 ↙	
3: 10.2 ↗	Total 450.7
4: 9.9 ⇒	
5: 10.5 ⇐	

1: 10.6 ↓	Serie 50.8
2: 9.8 ↗	
3: 10.2 ⇐	Total 501.5
4: 10.1 ←	
5: 10.1 ⇒	

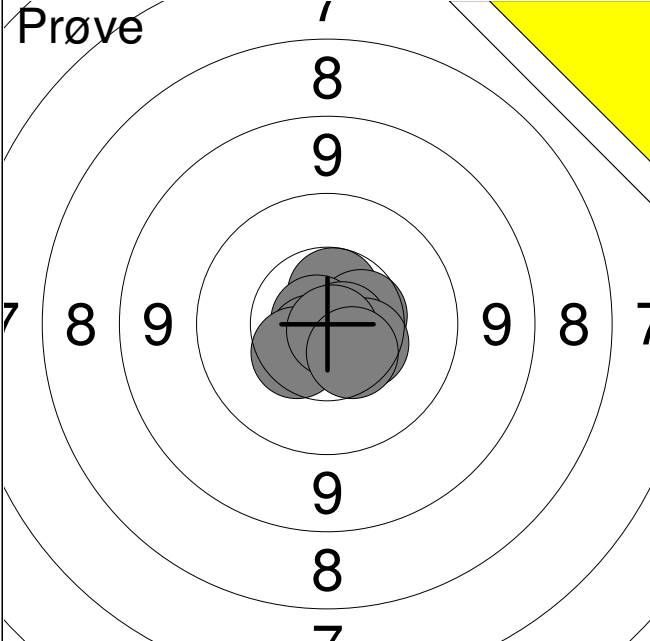
Hold 5	Skive 10	Nicolaj Nielsen		
Aalborg		Boddum-Ydby Skytteforening		BK L
02.03.2018		Nordjysk mesterskab Finaler		Aalborg Skyttekreds
Prøve				
		1:	10.7x	↘
		2:	10.4	↙
		3:	10.3	↘
		4:	10.5	↘
		5:	10.7x	↗
		6:	10.8x	↗
		7:	10.2	↖
		8:	10.0	↘
		Serie		83.6
		Total		399.0
1. Serie Finale				
		1:	10.9x	↗
		2:	10.7x	↗
		3:	10.7x	↗
		4:	10.6	↘
		5:	10.2	→
		Serie		53.1
		Total		452.1
2. Serie Finale				
		1:	10.8x	↗
		2:	10.4	↘
		3:	10.1	↗
		4:	10.6x	→
		5:	10.5	←
		Serie		52.4
		Total		504.5

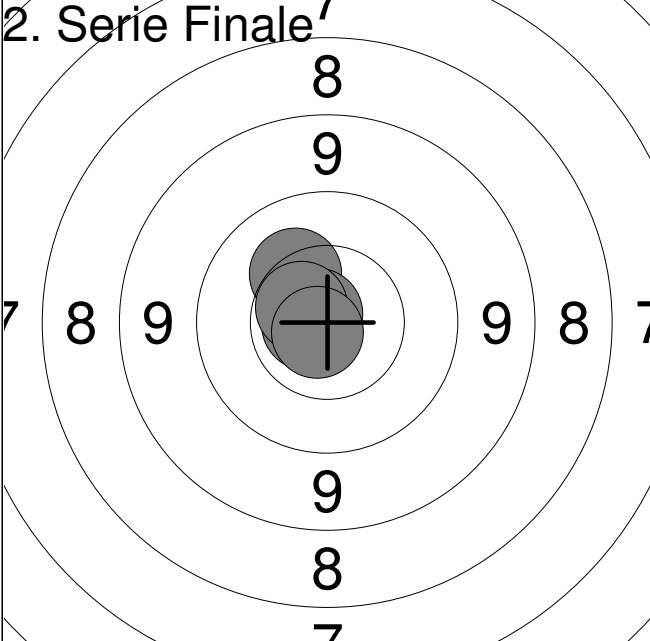
Hold	Skive	Emma Bai Hansen		
5	11	Aalborg	Kimbrene	BK L
02.03.2018		Nordjysk mesterskab Finaler	Aalborg Skyttekreds	
Prøve 	1:	10.8x	→	
	2:	10.6	↑	
	3:	10.5	→	
	4:	10.8x	←	
	5:	10.7x	↘	
	6:	10.8x	→	
	7:	10.5	↘	
	8:	10.5	↘	
	9:	10.8x	↘	
	10:	10.5	↘	
	Serie			106.5
Total			399.0	
1. Serie Finale 	1:	10.3	↗	
	2:	10.7x	↑	
	3:	10.3	↙	
	4:	10.5	←	
	5:	10.3	←	
	Serie			52.1
Total			451.1	
2. Serie Finale 	1:	10.3	↗	
	2:	10.7x	←	
	3:	10.8x	↗	
	4:	10.6x	↖	
	5:	10.8x	↘	
	Serie			53.2
Total			504.3	

Hold 5	Skive 12	Anna Nørregaard
------------------	--------------------	------------------------

Aalborg	Ulsted skytteforening	BK	L
---------	-----------------------	----	---

02.03.2018	Nordjysk mesterskab Finaler	Aalborg Skyttekreds
------------	-----------------------------	---------------------

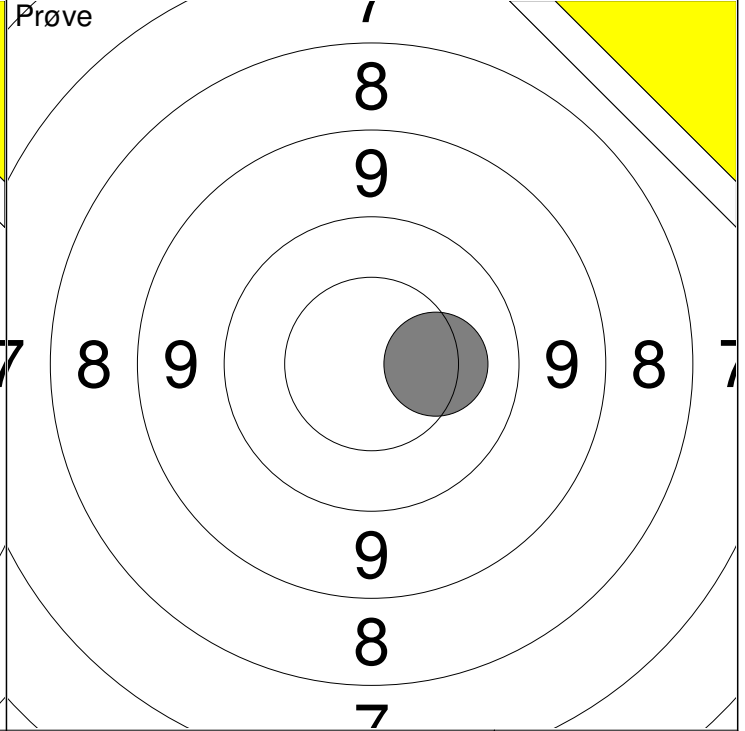
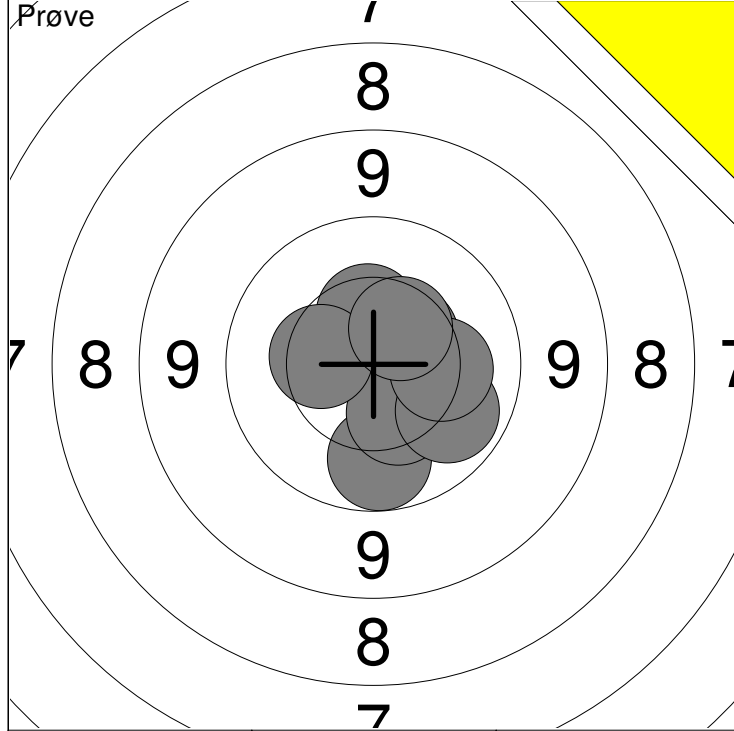

1: 10.6x →	6: 10.4 ↓	Serie	103.8
2: 10.5 ↗	7: 10.4 ←		
3: 10.8x →	8: 10.0 ↓	Total	399.0
4: 10.0 ↓	9: 10.2 →		
5: 10.4 ↑	10: 10.5 ↗		

11: 10.3 →	Serie	10.3
	Total	399.0

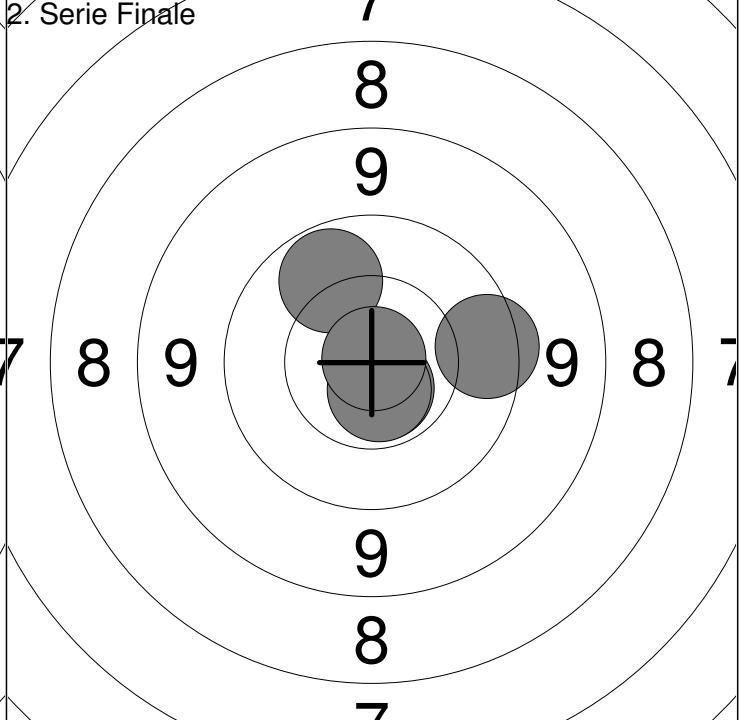
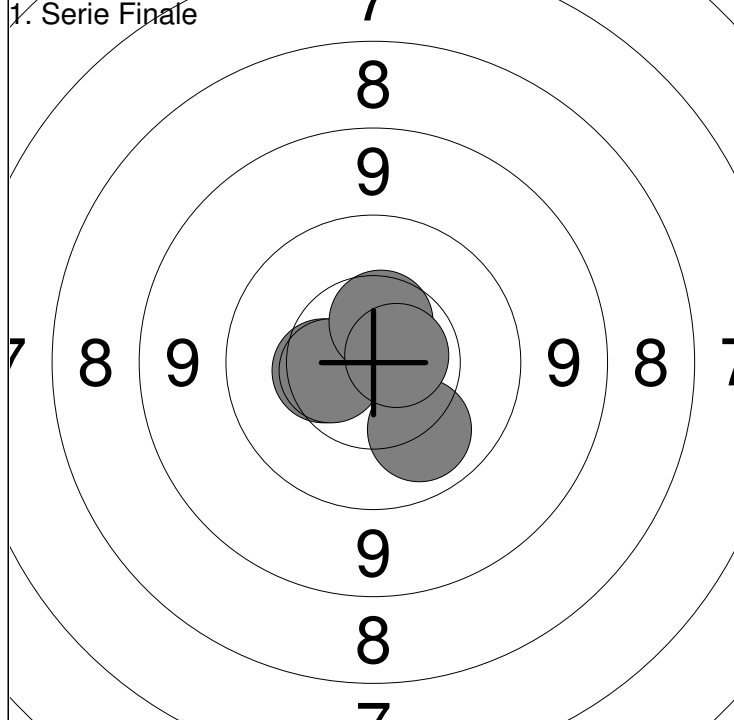

1: 10.4 ←	Serie	52.2
2: 10.5 ←		
3: 10.5 ↑	Total	451.2
4: 10.1 ↓		
5: 10.7x →		

1: 10.7x ↓	Serie	52.0
2: 10.7x ↓		
3: 10.0 ↗	Total	503.2
4: 10.9x ↗		
5: 9.7 →		

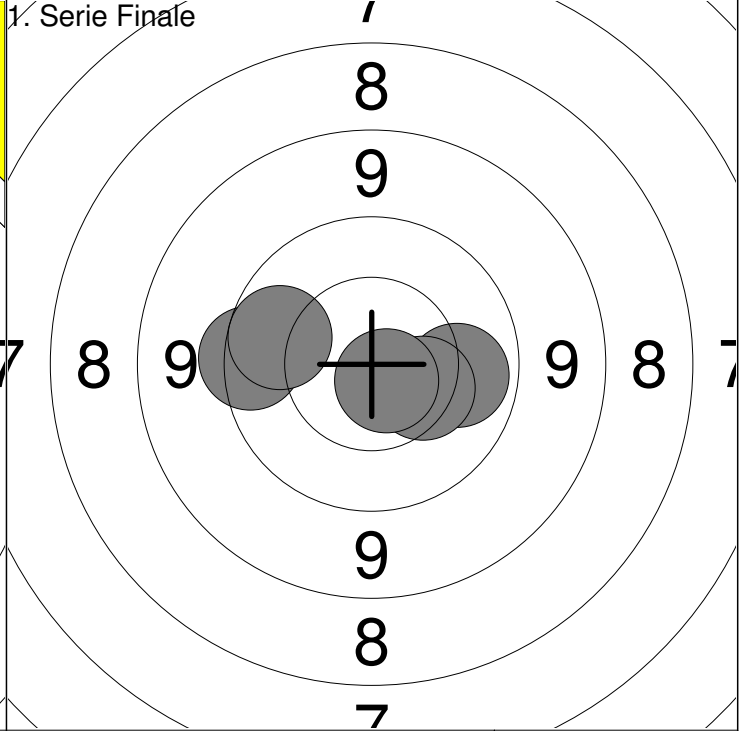
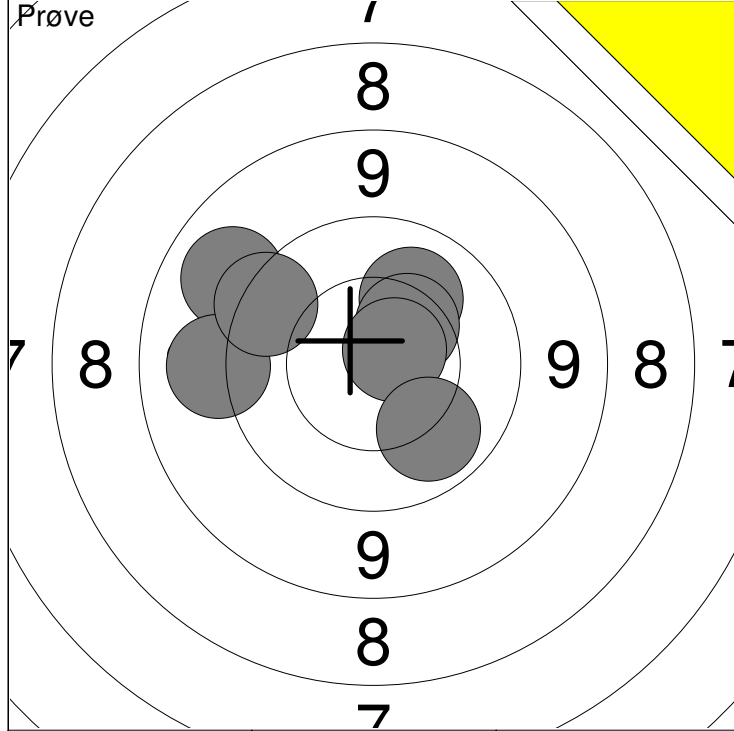

1: 9.2 ↖	6: 10.7x ↗	Serie	69.5
2: 9.3 ←	7: 10.1 ↘		
3: 9.6 ↖		Total	400.0
4: 10.2 ↗			
5: 10.4 ↗			

1: 10.0 →	Serie	50.8
2: 10.4 ↘		
3: 10.7x ↘	Total	450.8
4: 9.7 ←		
5: 10.0 ←		

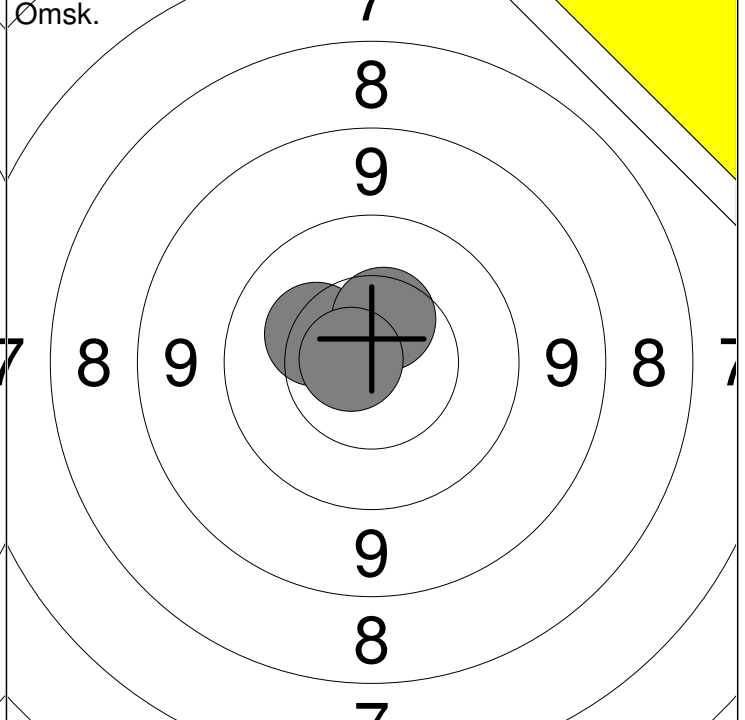
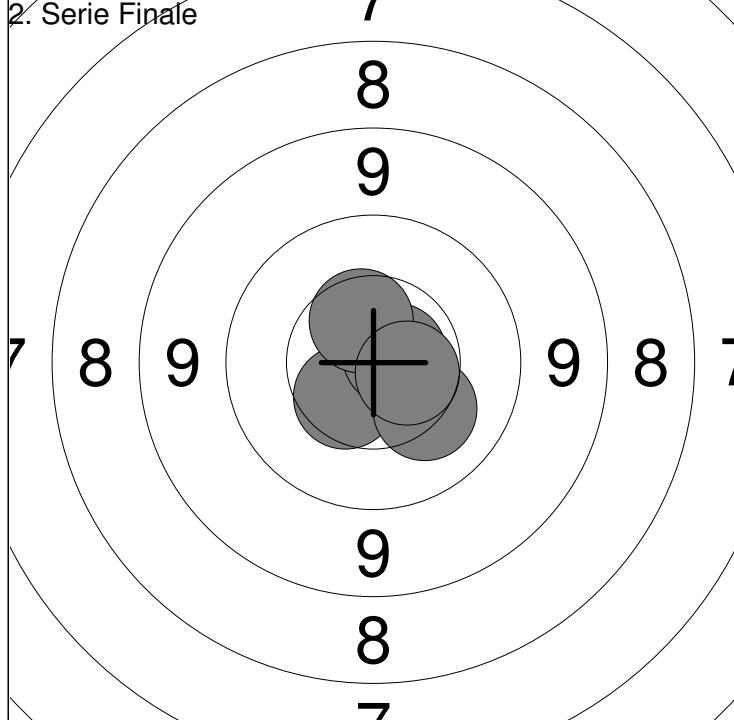

1: 10.5 ↘	Serie	52.5
2: 10.7x ↗		
3: 10.2 ↘	Total	503.3
4: 10.5 ↗		
5: 10.6 →		

1: 10.3 ↖	Serie	31.5
2: 10.5 ↗		
3: 10.7x ←	Total	503.3

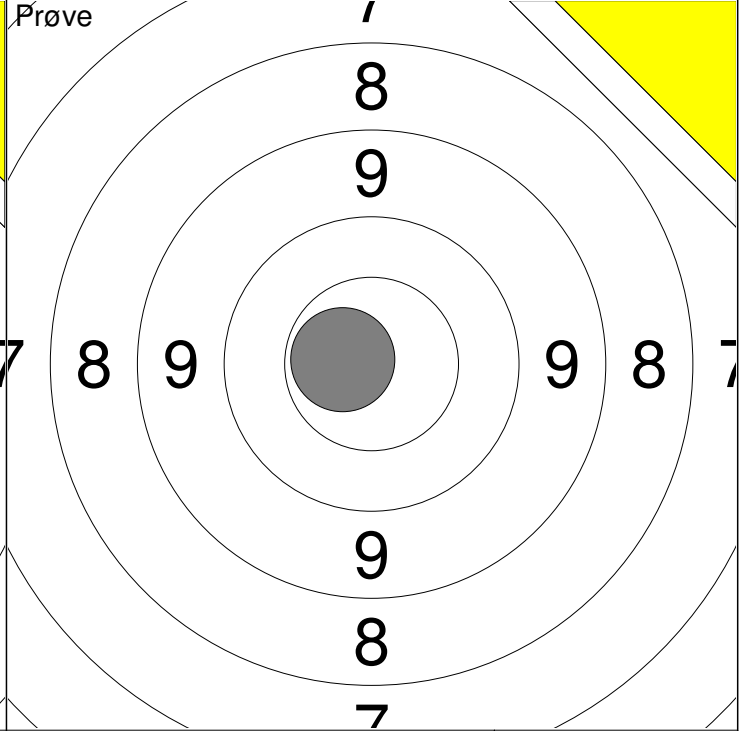
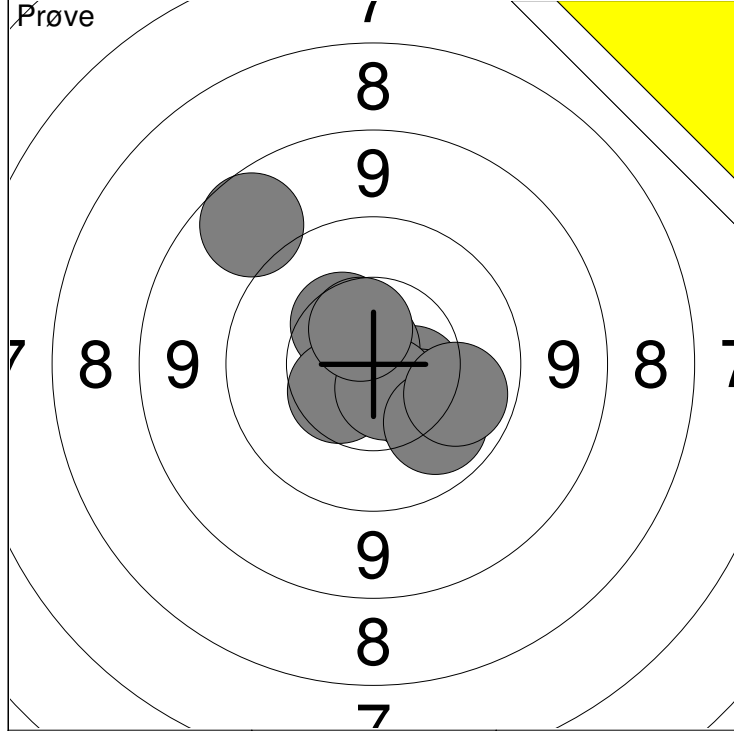

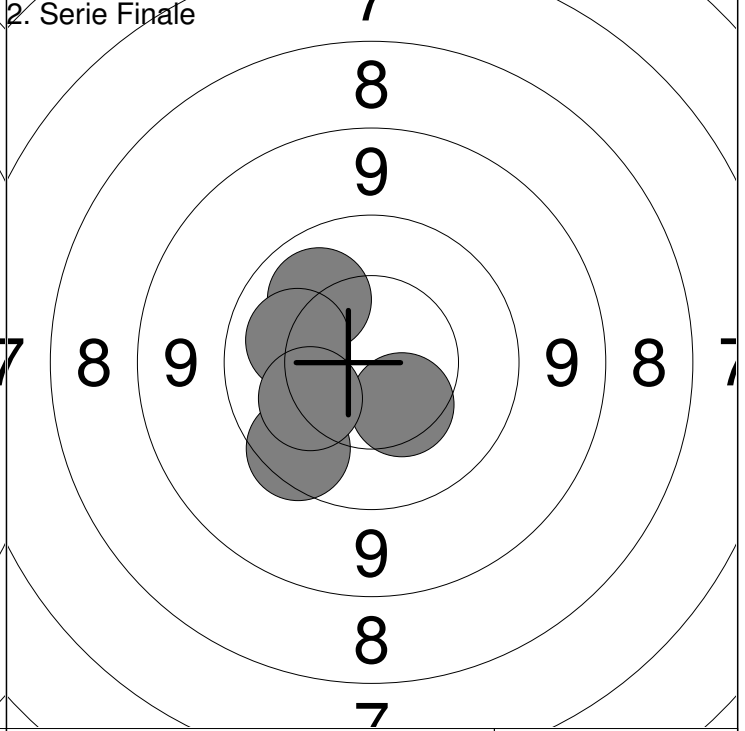
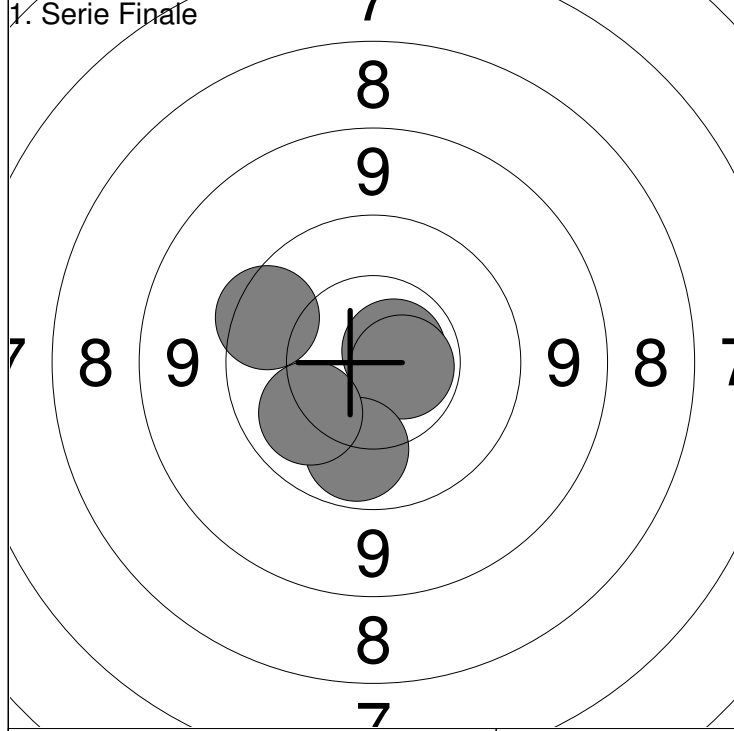

1: 8.9 ↗	6: 10.3 ↘	Serie 102.8
2: 10.4 ↗	7: 10.7x ↘	
3: 10.5 ↘	8: 10.6 ↗	Total 399.0
4: 10.8x ↗	9: 10.1 ↘	
5: 10.5 ↘	10: 10.0 ↘	

11: 10.6x ←	Serie 10.6
	Total 399.0

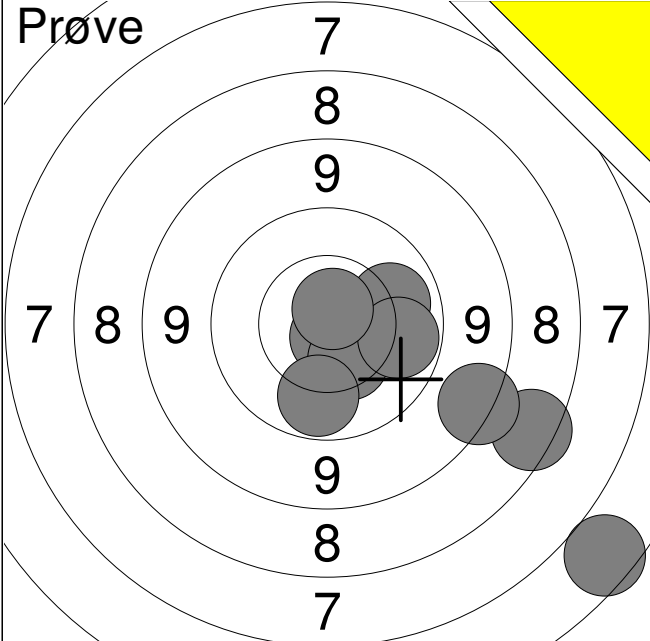

1: 10.7x ↗	Serie 51.1
2: 10.6x →	
3: 10.0 ↘	Total 450.1
4: 9.7 ↖	
5: 10.1 ↘	

1: 10.4 ↘	Serie 50.5
2: 10.1 ↗	
3: 9.7 ↘	Total 500.6
4: 10.1 ↖	
5: 10.2 ↘	

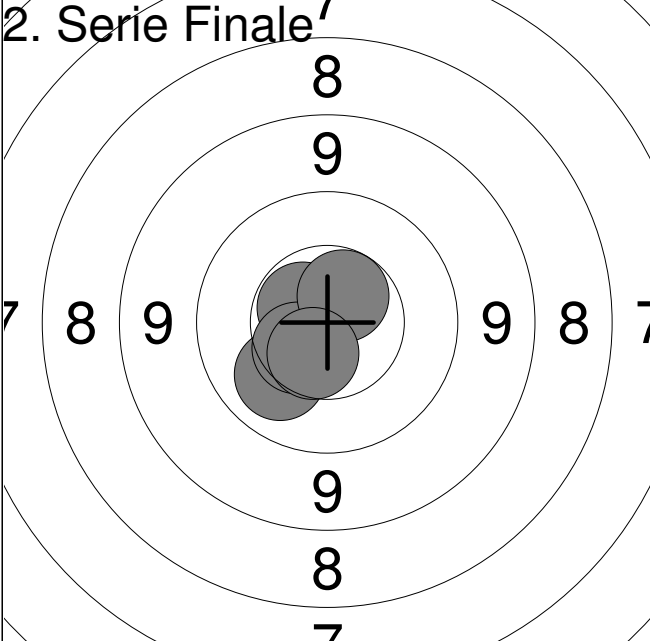
Hold 6	Skive 4	Victoria Riemana Dahl		
Aalborg		Boddum-Ydby Skytteforening		JUN L
02.03.2018		Nordjysk mesterskab Finaler		Aalborg Skyttekreds
Prøve				
		1:	5.8	↘
		2:	7.7	↘
		3:	8.5	↘
		4:	10.1	→
		5:	10.8x	↘
		6:	10.4	↘
		7:	10.0	→
		8:	10.0	↘
		9:	10.7x	↗
		Serie	84.0	
		Total	399.0	
1. Serie Finale				
		1:	10.1	↗
		2:	10.2	↘
		3:	10.2	↓
		4:	10.3	↙
		5:	10.6x	↑
		Serie	51.4	
		Total	450.4	
2. Serie Finale				
		1:	10.6x	↖
		2:	10.1	↘
		3:	10.5	↙
		4:	10.6x	↗
		5:	10.5	↘
		Serie	52.3	
		Total	502.7	

Hold 6	Skive 5	Kian Nedrud Møller			
Aalborg		Vodskov Skytteforening	JUN	L	
02.03.2018		Nordjysk mesterskab Finaler	Aalborg Skyttekreds		
Prøve			1:	9.8	↘
			2:	9.4	→
			3:	10.3	→
			4:	10.2	↘
			5:	9.7	↗
			6:	10.0	↓
			7:	10.8x	↗
			8:	10.2	↗
			9:	9.8	↗
			10:	10.6x	↓
			Serie	100.8	
		Total	399.0		
1. Serie Finale			1:	10.6	←
			2:	10.4	↓
			3:	9.7	↗
			4:	10.5	↗
			5:	10.6x	↓
			Serie	51.8	
		Total	450.8		
2. Serie Finale			1:	9.7	↘
			2:	10.6	↘
			3:	10.2	↗
			4:	10.1	↑
			5:	10.1	←
			Serie	50.7	
		Total	501.5		

Hold	Skive	Nina Guldbæk Larsen			
6	6	Vodskov Skytteforening		JUN	L
02.03.2018		Nordjysk mesterskab Finaler		Aalborg Skyttekreds	
Prøve 	1: 10.1 ↑	Prøve 	11: 10.3 ↑		
	2: 10.1 →		12: 10.9x →		
	3: 9.9 ↑				
	4: 9.7 ↗				
	5: 10.6x →				
	6: 10.3 ←				
	7: 10.2 ↗				
	8: 10.3 ←				
	9: 10.5 ↑				
	10: 10.6x ↓				
	Serie 102.3			Serie 21.2	
	Total 398.0			Total 398.0	
1. Serie Finate 	1: 10.7x ←	2. Serie Finate 	1: 10.7x ↖		
	2: 10.7x ↓		2: 10.8x ↑		
	3: 10.8x ←		3: 10.3 →		
	4: 9.9 ↑				
	5: 10.4 ←				
	Serie 52.5			Serie 52.8	
	Total 450.5			Total 503.3	
Ømsk. 	1: 10.1 →				
	2: 10.0 ↗				
	3: 10.8x →				
	Serie 30.9				
	Total 503.3				

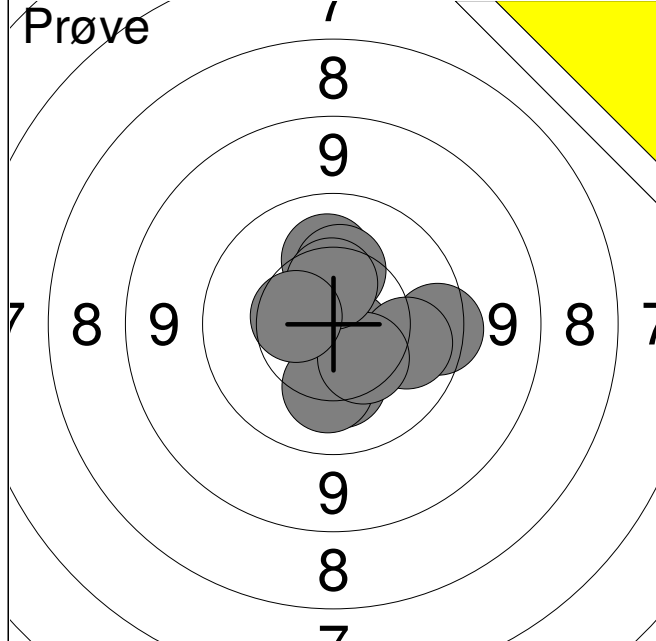

1:	10.3	↓
2:	10.7x	↘
3:	9.7	→
4:	10.1	→
5:	10.2	↓
6:	10.4	↘
7:	10.2	↑
8:	10.3	↑
9:	10.5	↑
10:	10.5	←
Serie		102.9
Total		397.0

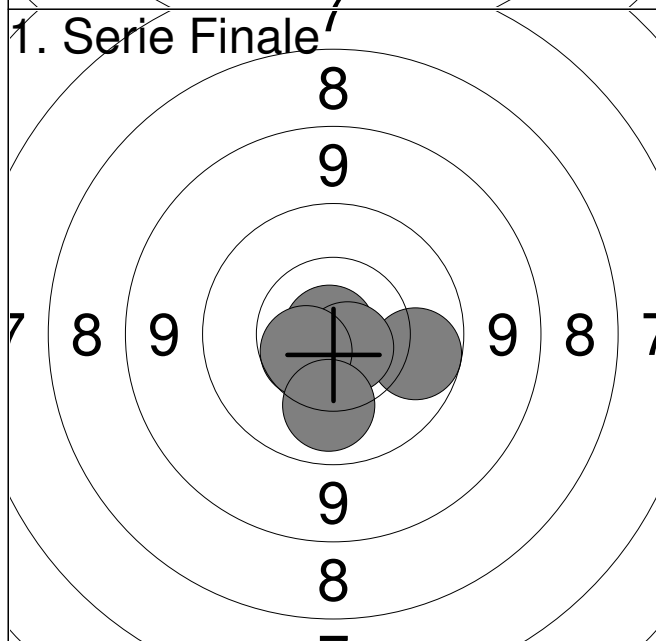

1:	9.9	→
2:	10.9x	↗
3:	10.7x	↘
4:	10.6	←
5:	10.1	↓
Serie		52.2
Total		449.2

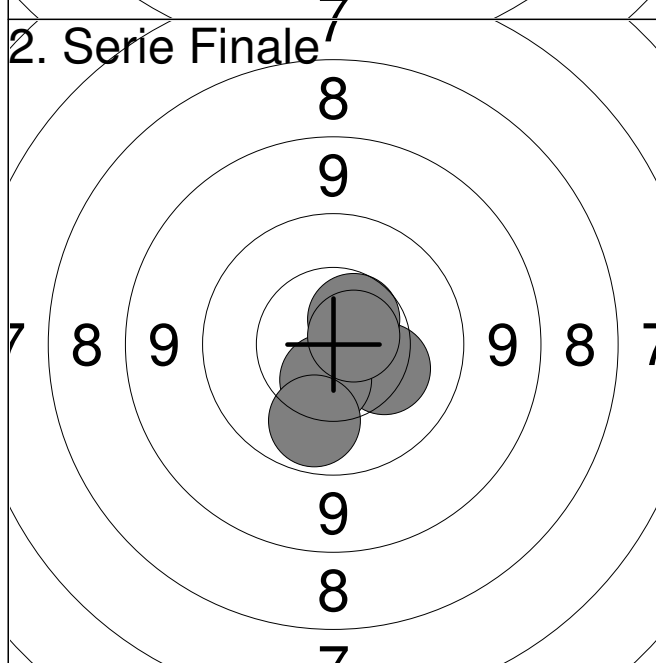

1:	10.3	→
2:	10.6	↗
3:	10.5	↓
4:	10.0	↓
5:	10.7x	→
Serie		52.1
Total		501.3

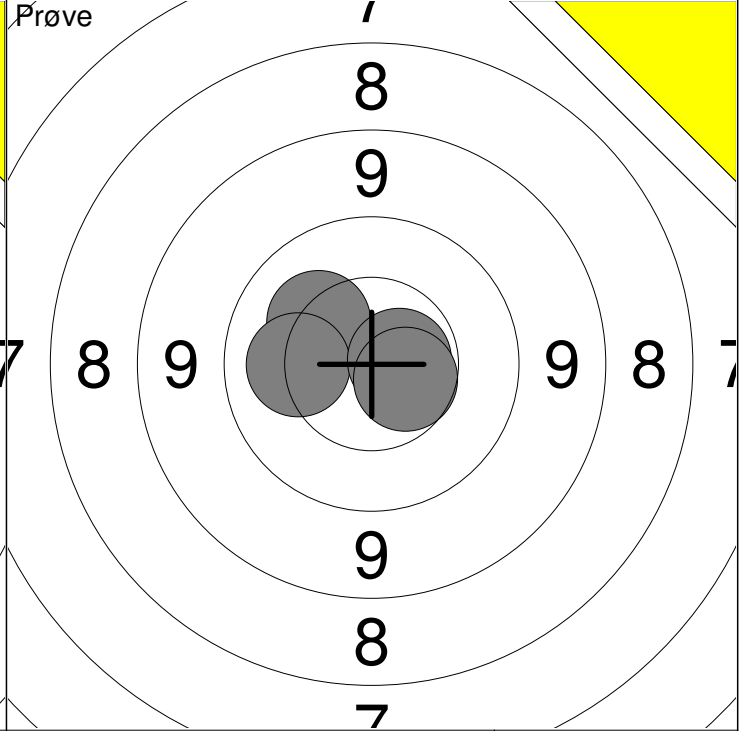
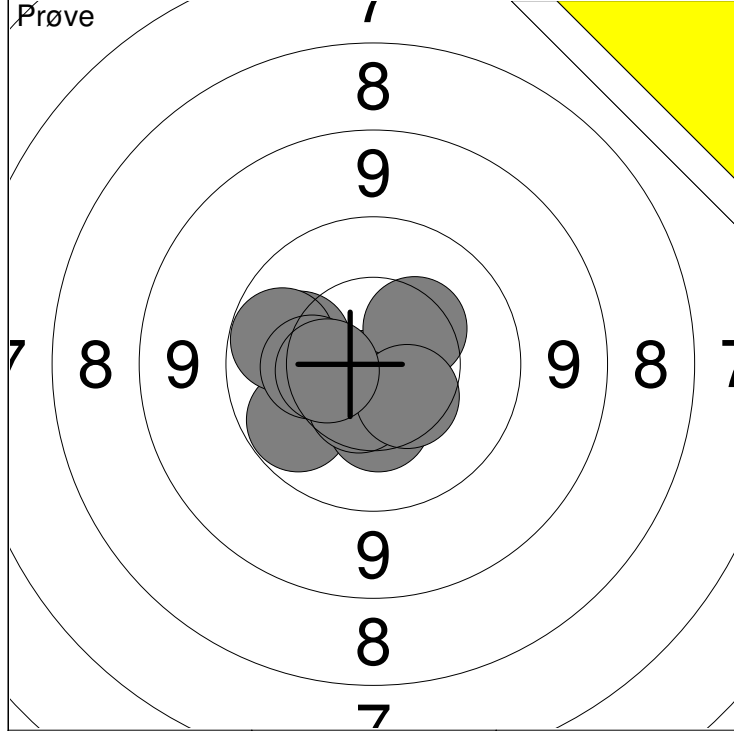

1: 10.8x ↓	6: 10.4 ↓	Serie	103.5
2: 10.0 ↙	7: 10.5 ↓		
3: 10.1 ←	8: 10.5 ↘	Total	400.0
4: 10.0 ←	9: 10.3 ←		
5: 10.4 ↗	10: 10.5 ←		

11: 10.2 ↖	Serie	41.7
12: 10.2 ←		
13: 10.7x →	Total	400.0
14: 10.6 ↘		

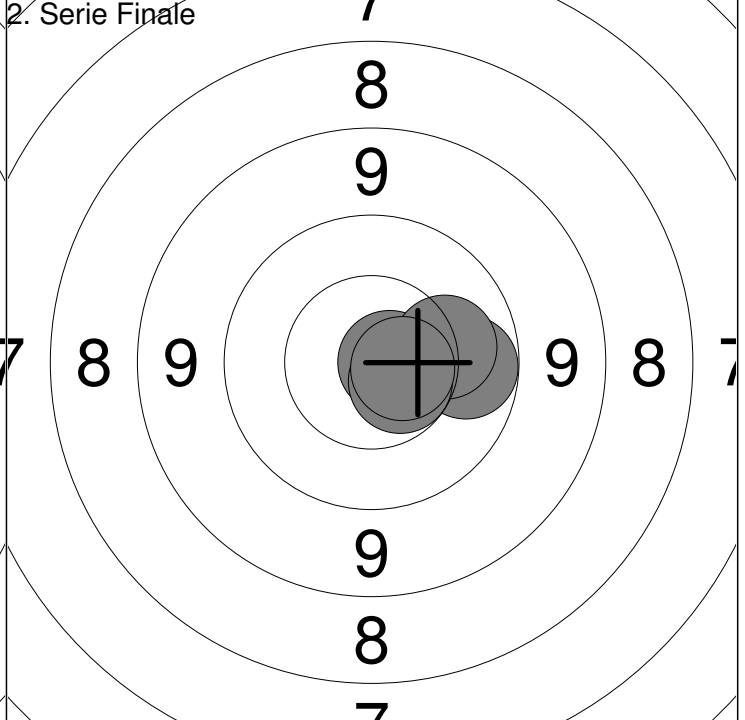
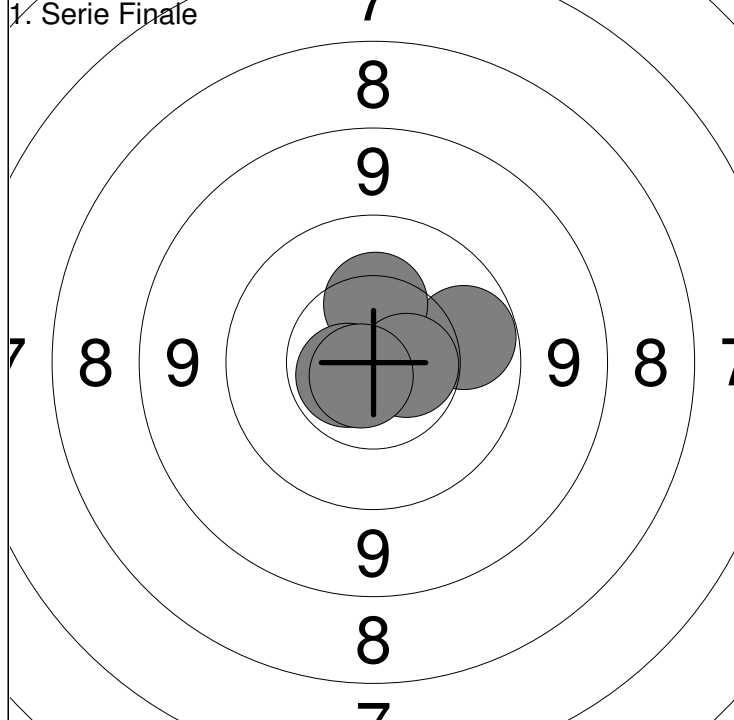

1: 10.0 →	Serie	52.4
2: 10.3 ↑		
3: 10.7x ↙	Total	452.4
4: 10.6x →		
5: 10.8x ↘		

1: 10.8x →	Serie	52.2
2: 10.0 →		
3: 10.2 →	Total	504.6
4: 10.6x ↘		
5: 10.6x →		

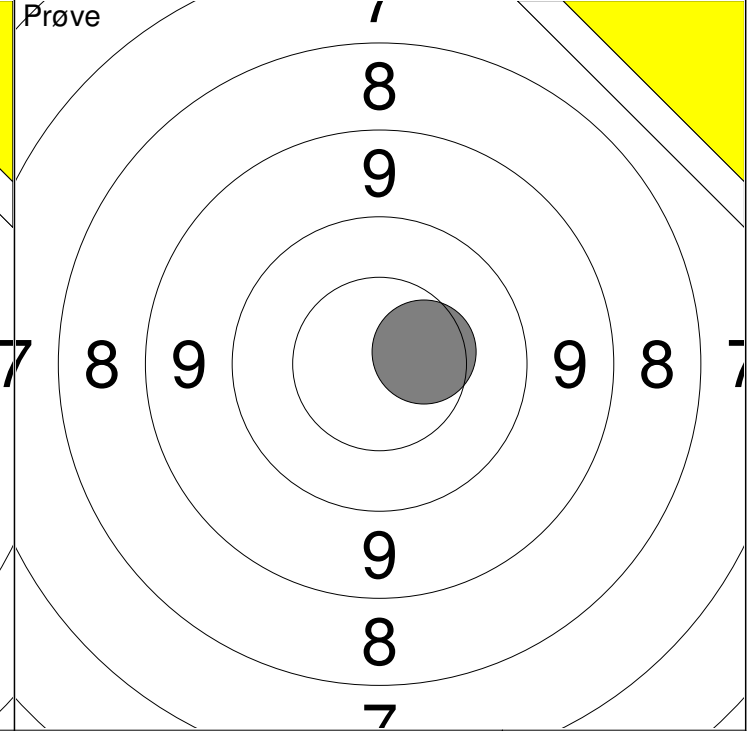
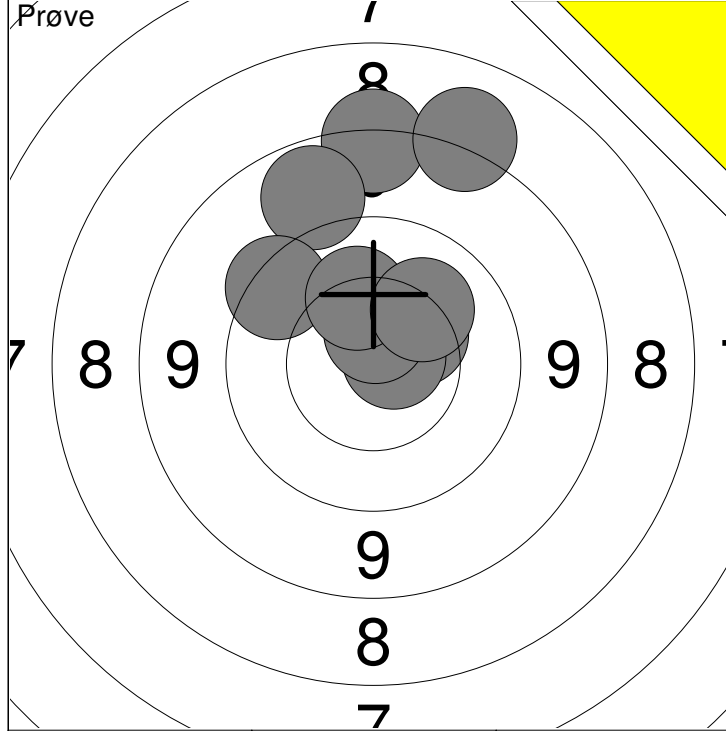

1: 8.5 ↑	6: 10.4 ↗	Serie 98.1
2: 8.3 ↑	7: 10.7x →	
3: 9.0 ↑	8: 10.6x ↑	Total 397.0
4: 9.6 ↖	9: 10.2 ↑	
5: 10.6 ↗	10: 10.2 ↗	

11: 10.5 →	Serie 10.5
	Total 397.0

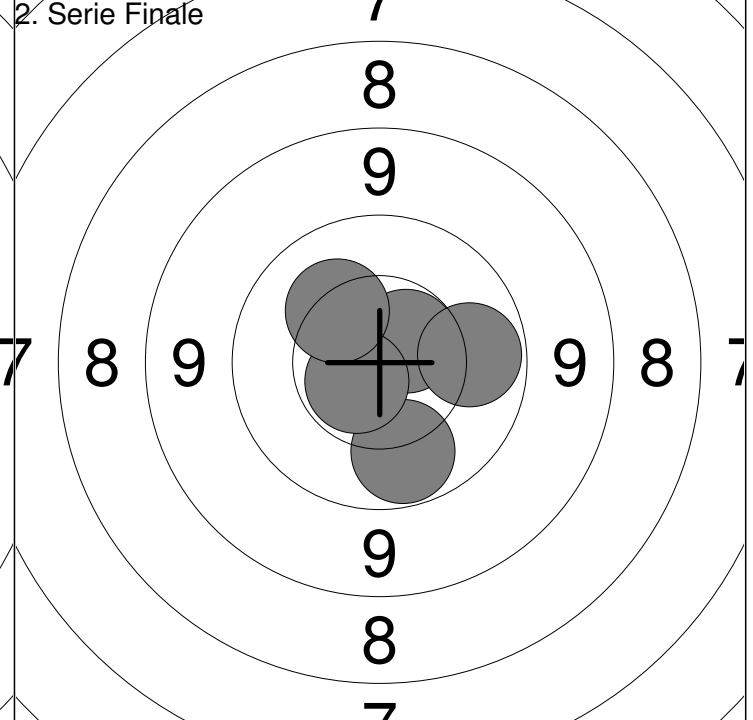
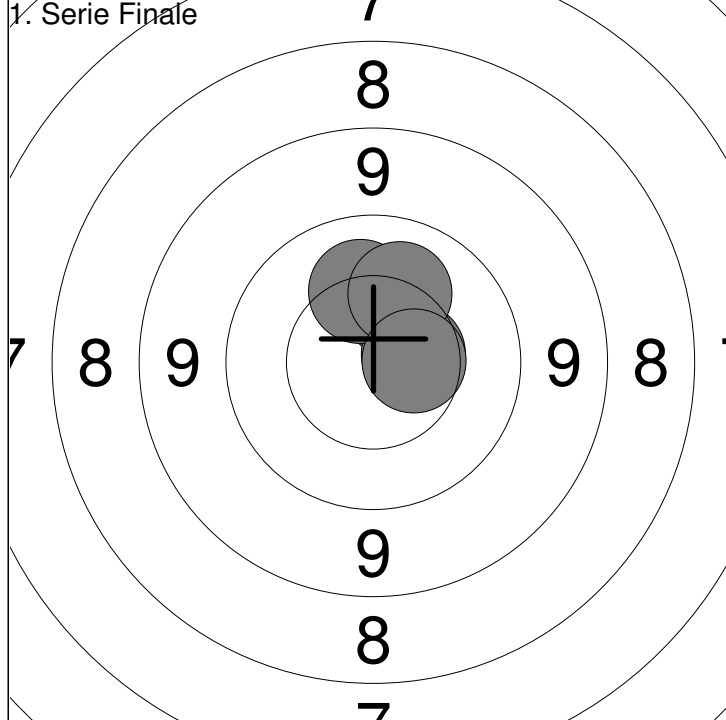

1: 10.3 ↑	Serie 51.7
2: 10.5 →	
3: 10.2 ↑	Total 448.7
4: 10.2 ↑	
5: 10.5 →	

1: 10.6x ↗	Serie 51.5
2: 10.0 ↓	
3: 10.6x ↖	Total 500.2
4: 10.0 →	
5: 10.3 ↖	

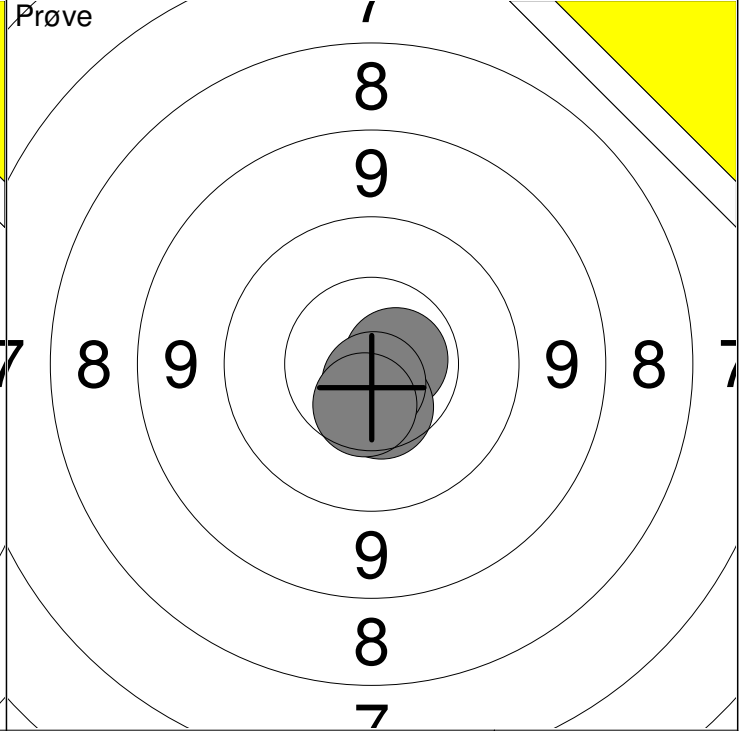
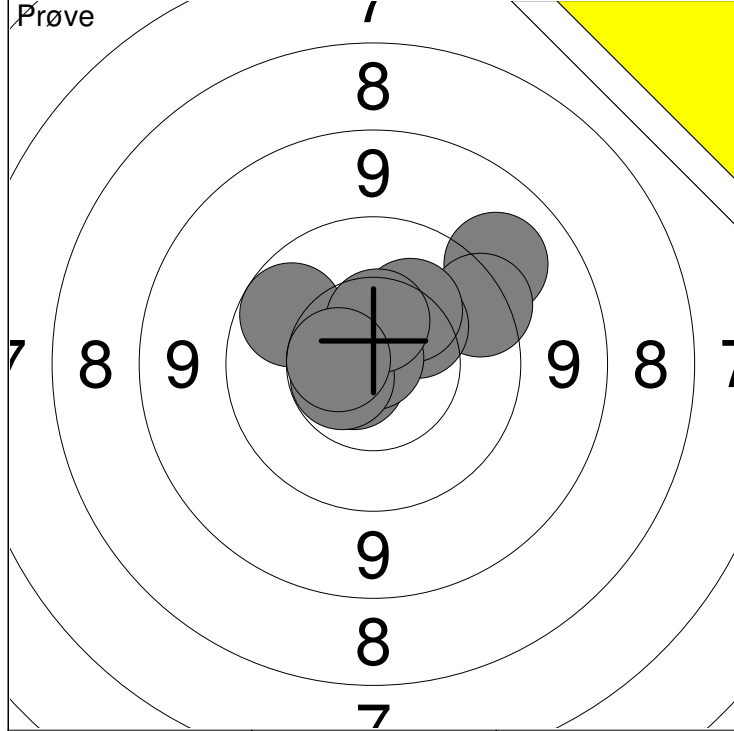

1: 9.2 ↗	6: 10.9x ↑	Serie 102.6
2: 9.6 ↗	7: 10.6x ←	
3: 10.3 ↗	8: 9.9 ↖	Total 397.0
4: 10.7x ↙	9: 10.5 ↑	
5: 10.3 ↗	10: 10.6 ←	

11: 10.7x →	Serie 42.4
12: 10.5 ↓	
13: 10.7x ↓	Total 397.0
14: 10.5 ↓	

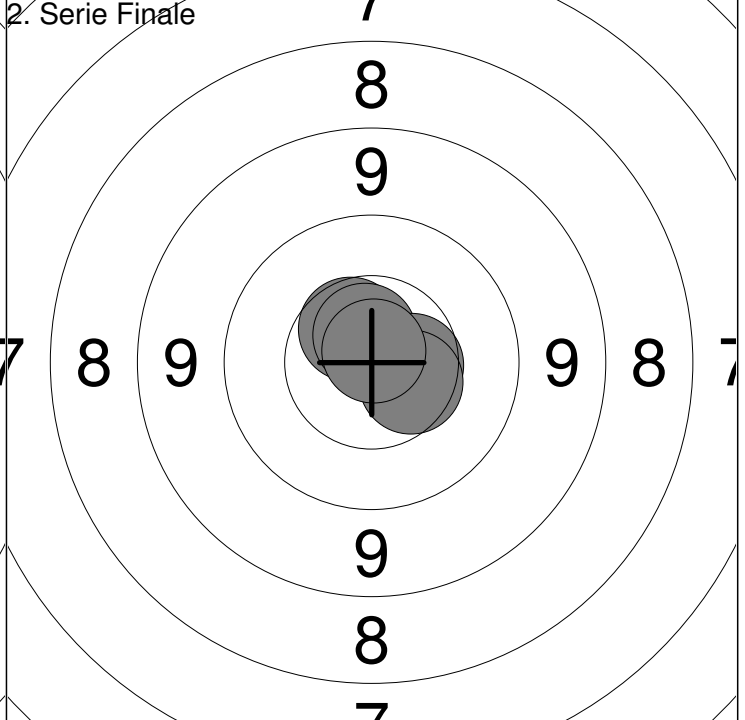
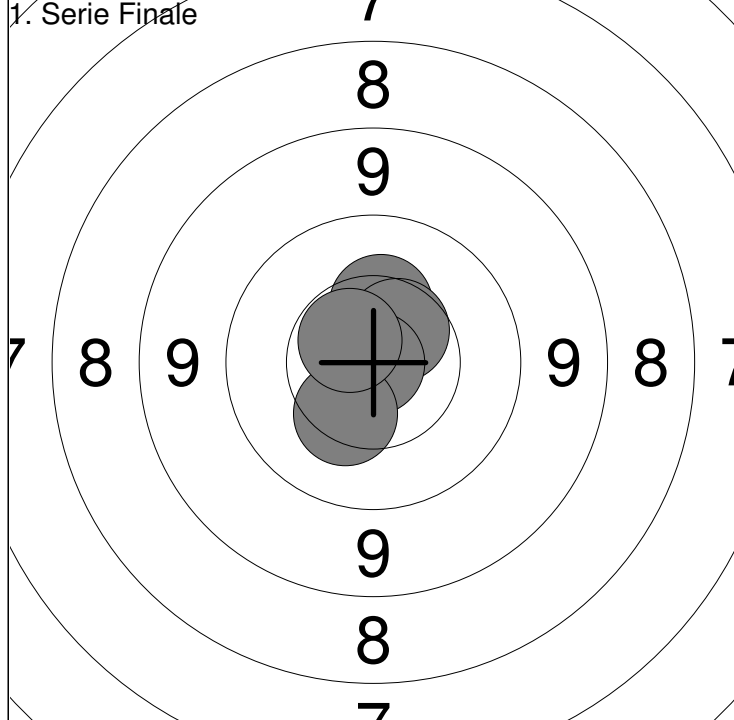

1: 10.4 ↑	Serie 52.7
2: 10.5 ↗	
3: 10.9x ↙	Total 449.7
4: 10.3 ↙	
5: 10.6x ↖	

1: 10.5 ↖	Serie 53.0
2: 10.7x ↑	
3: 10.5 →	Total 502.7
4: 10.5 ↘	
5: 10.8x ↑	

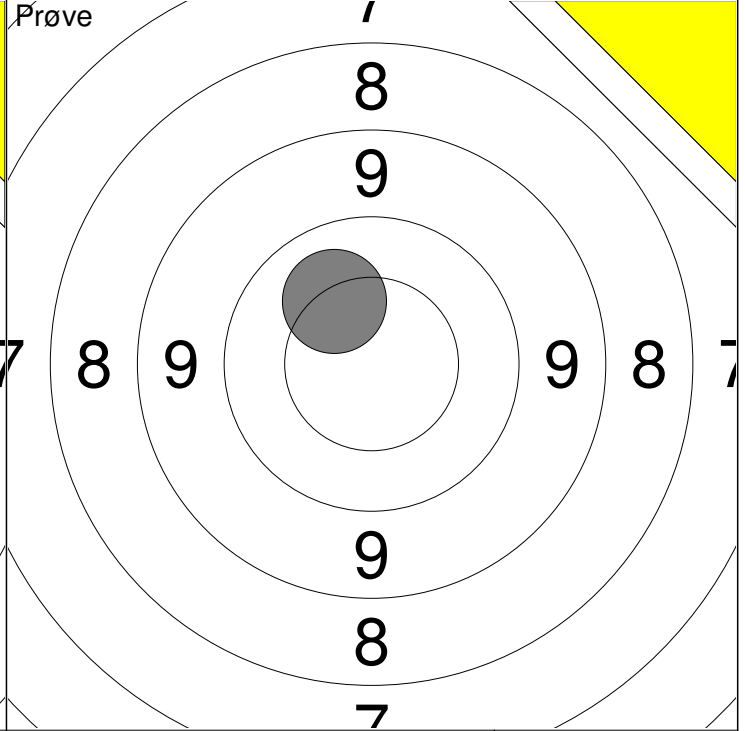
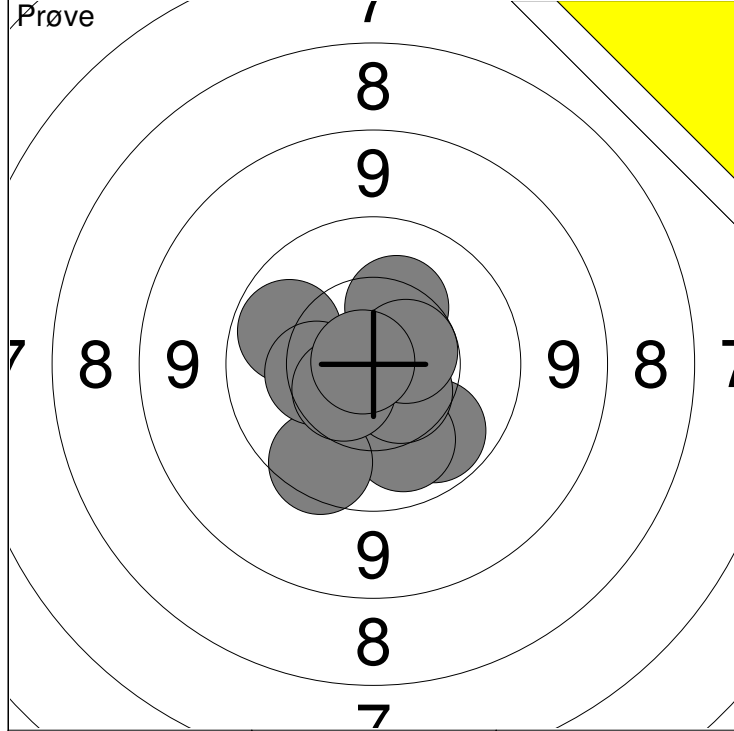

1: 10.0 ↘	6: 9.8 ↘	Serie 103.0
2: 10.1 ↘	7: 10.4 ←	
3: 10.5 ↘	8: 10.5 ↘	Total 396.0
4: 10.3 ↗	9: 10.6x →	
5: 10.0 ←	10: 10.8x ←	

11: 10.2 ↗	Serie 10.2
Total 396.0	

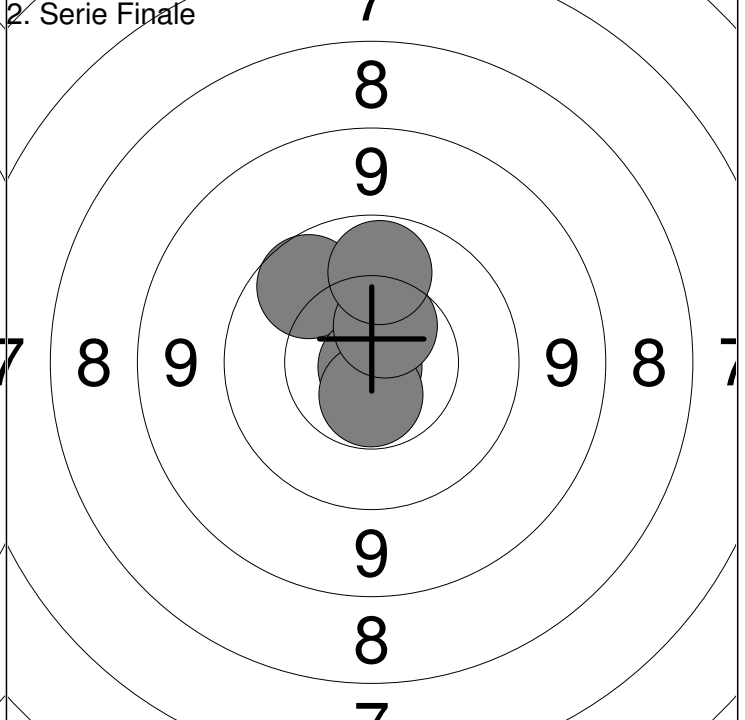
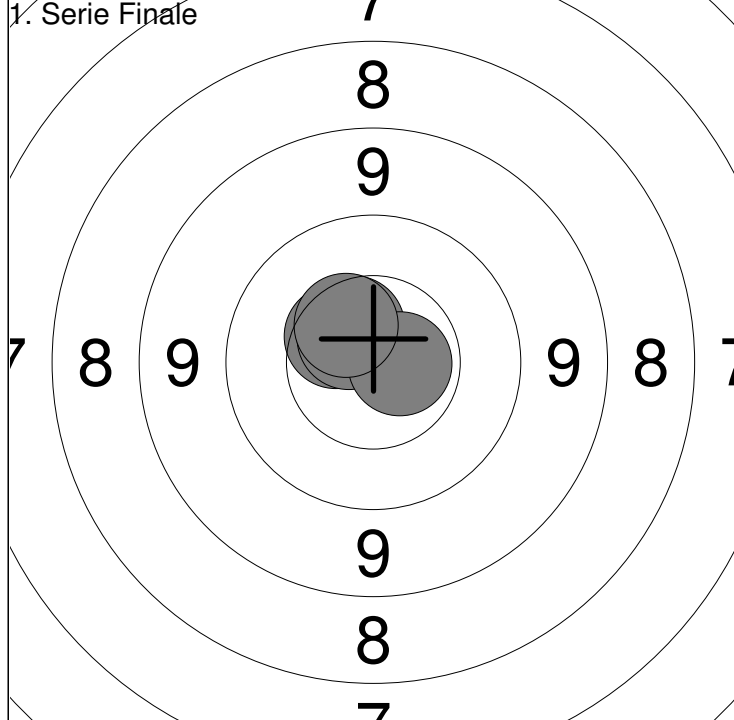

1: 10.5 ↗	Serie 52.8
2: 10.5 ↗	
3: 10.6x ↗	Total 448.8
4: 10.7x →	
5: 10.5 ↗	

1: 9.9 ↖	Serie 51.9
2: 10.9x ↘	
3: 10.6x ↘	Total 500.7
4: 10.5 ↗	
5: 10.0 ↗	

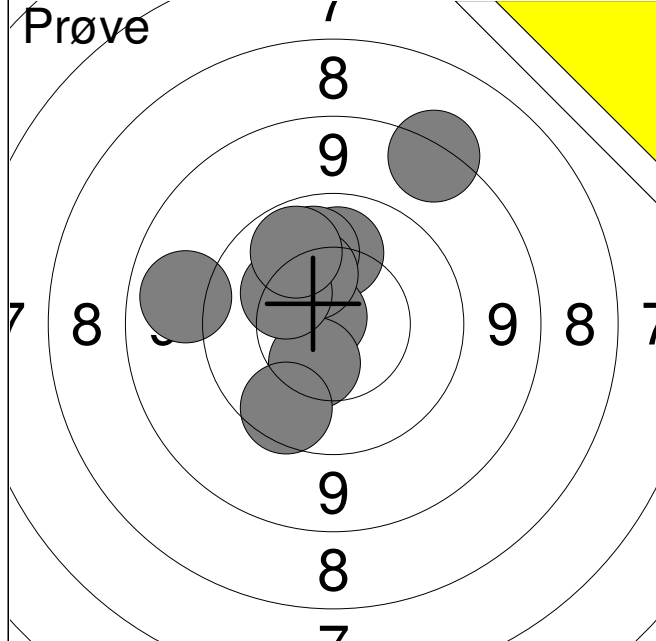

1:	9.1	←
2:	10.1	↑
3:	10.8x	↖
4:	10.1	↑
5:	10.3	↑
6:	8.5	↗
7:	10.4	↓
8:	9.8	↓
9:	10.3	↖
10:	10.0	↑
Serie		99.4
Total		396.0

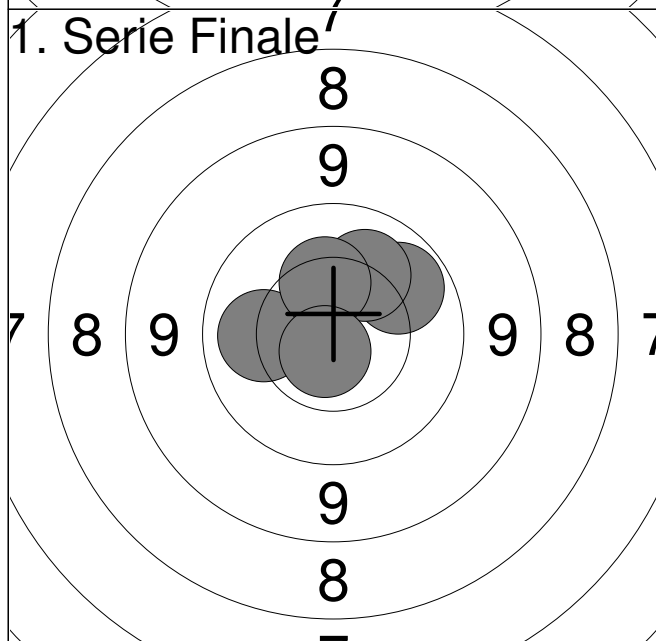

1:	10.0	↗
2:	10.2	↑
3:	10.1	←
4:	10.3	↑
5:	10.7x	↓
Serie		51.3
Total		447.3

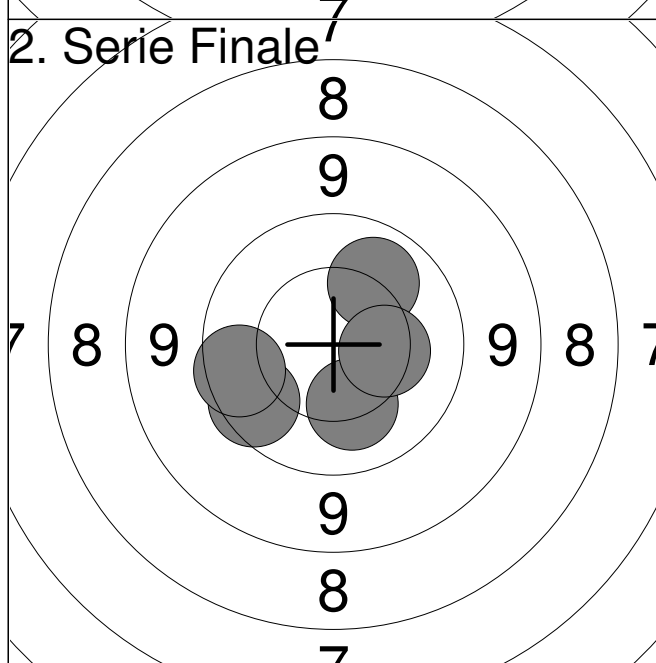

1:	9.8	↙
2:	9.8	←
3:	10.2	↓
4:	10.1	↗
5:	10.3	→
Serie		50.2
Total		497.5

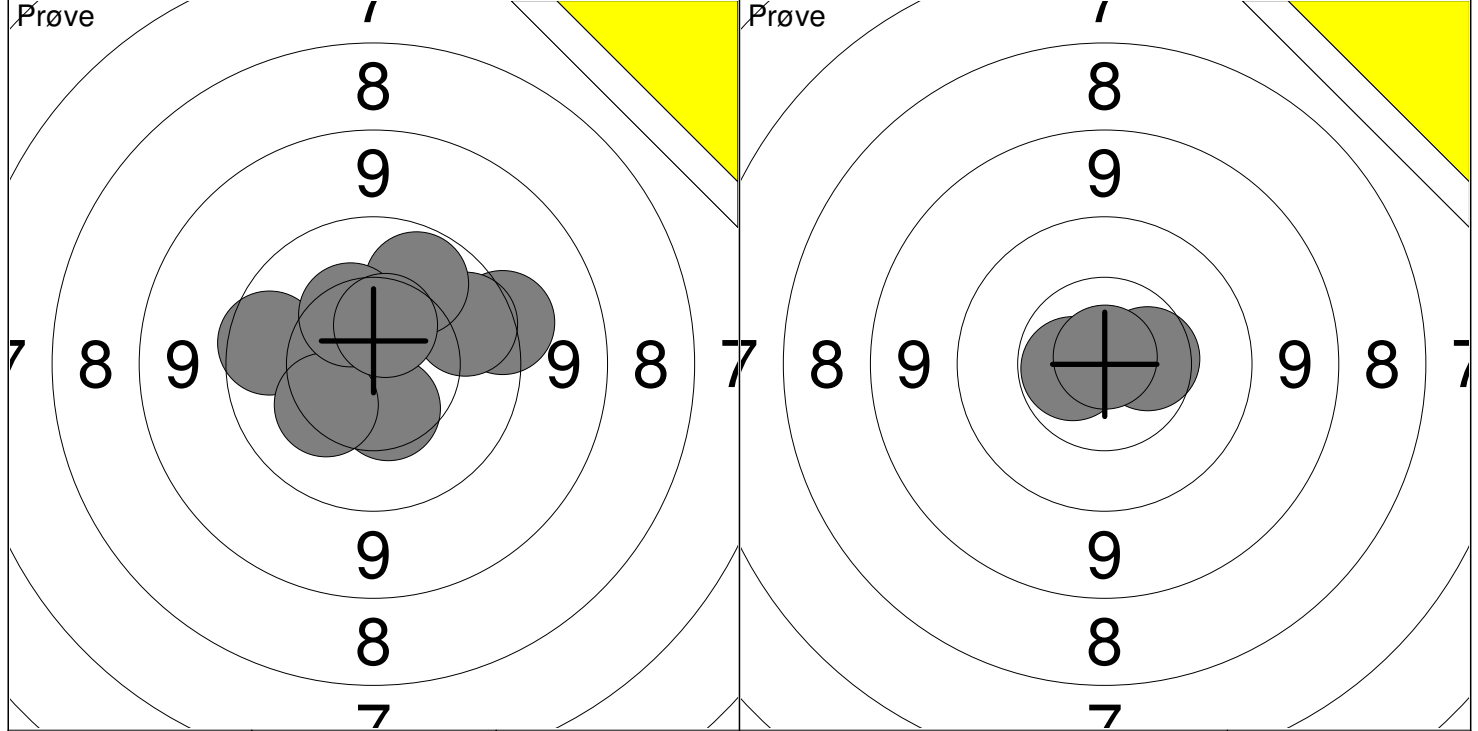

1: 9.5 →	6: 10.3 ↗	Serie	101.7	11: 10.6x ←	Serie	32.0
2: 10.5 ↖	7: 9.9 →			12: 10.5 →		
3: 10.5 ↓	8: 10.0 ↗	Total	400.0	13: 10.9x ↑	Total	400.0
4: 9.8 ←	9: 10.4 ↗			10: 10.5 ↗		
5: 10.3 ↙						

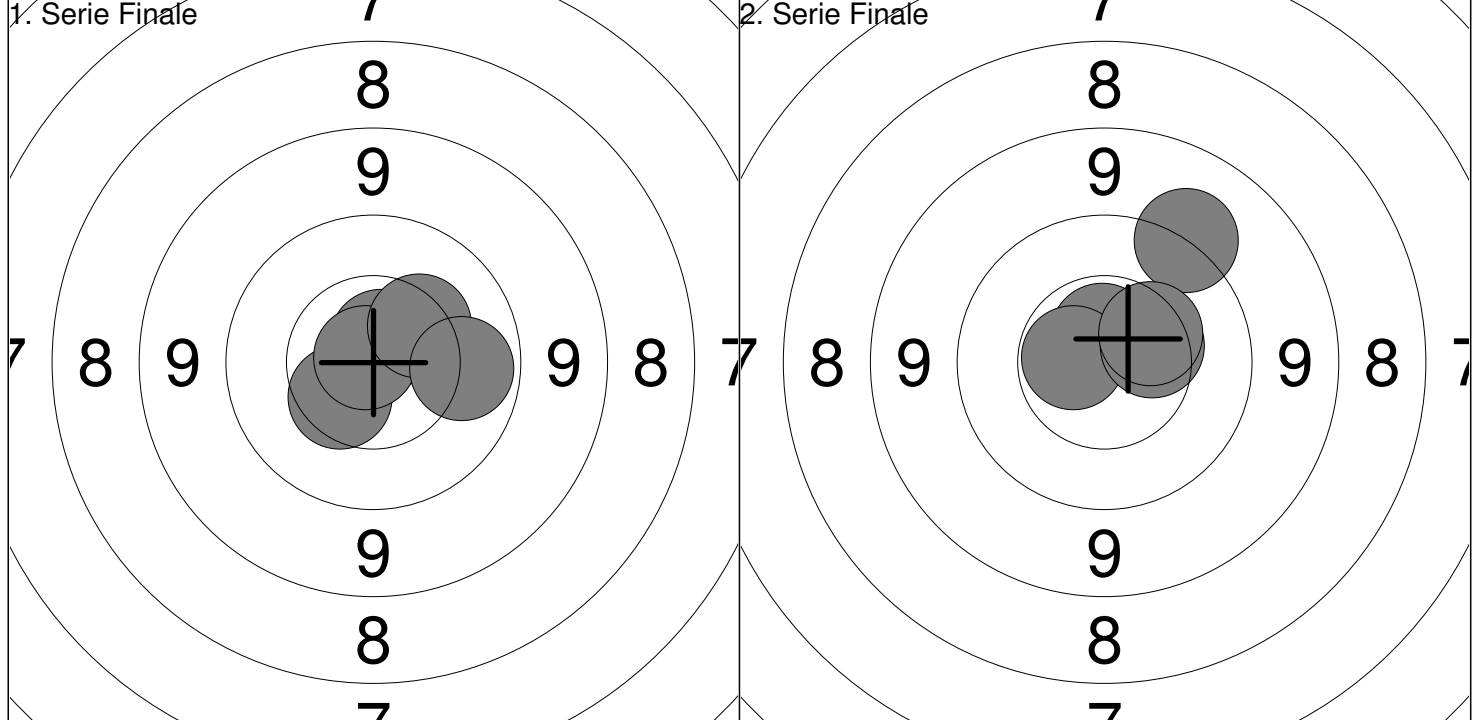

1: 10.7x ↗	Serie	52.3	1: 10.7x ↗	Serie	51.5
2: 10.4 ↙			2: 9.4 ↗		
3: 10.9x ↖	Total	452.3	3: 10.6x ←	Total	503.8
4: 10.3 ↗			4: 10.4 →		
5: 10.0 →			5: 10.4 ↗		

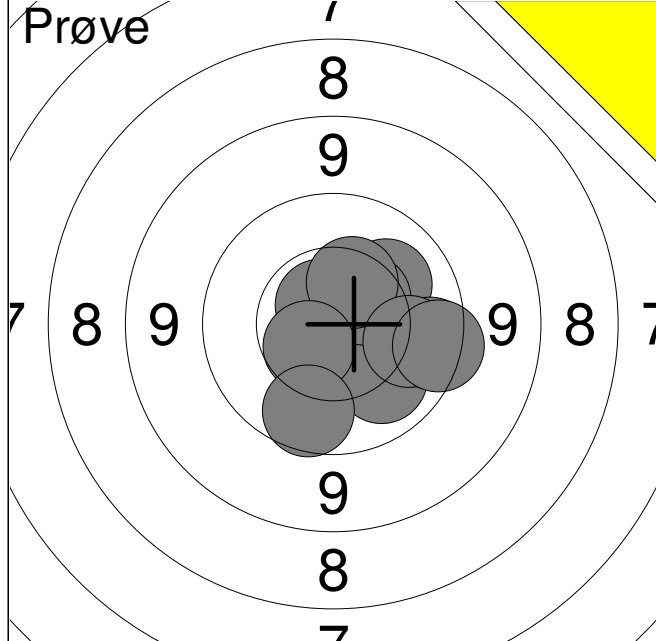

1:	10.2	↗
2:	10.7x	↗
3:	10.1	↘
4:	10.5	↗
5:	10.4	↗
6:	9.8	→
7:	10.6	↙
8:	10.0	→
9:	9.7	→
10:	9.9	↓
Serie	101.9	
Total	399.0	

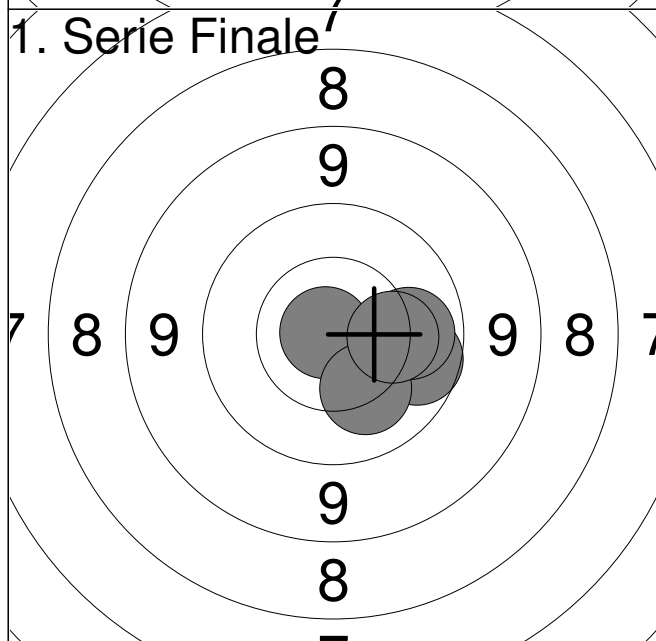

1:	9.9	→
2:	10.9x	←
3:	10.1	→
4:	10.2	↘
5:	10.2	→
Serie	51.3	
Total	450.3	

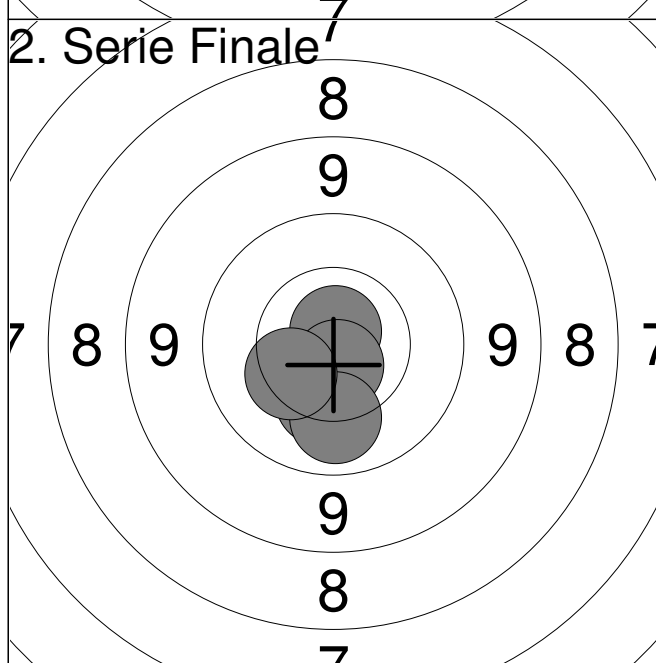

1:	10.8x	↑
2:	10.3	↓
3:	10.7x	↓
4:	10.1	↓
5:	10.3	↙
Serie	52.2	
Total	502.5	

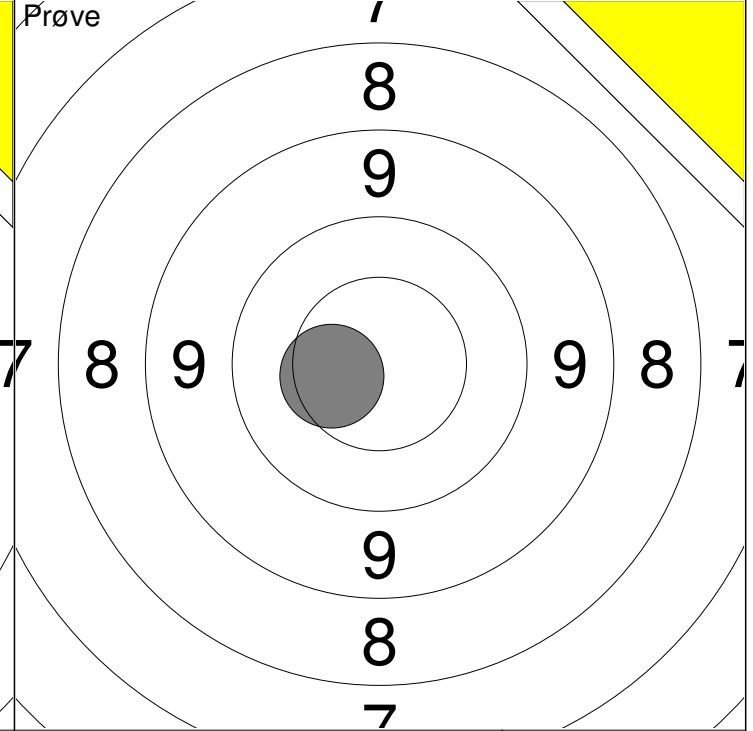
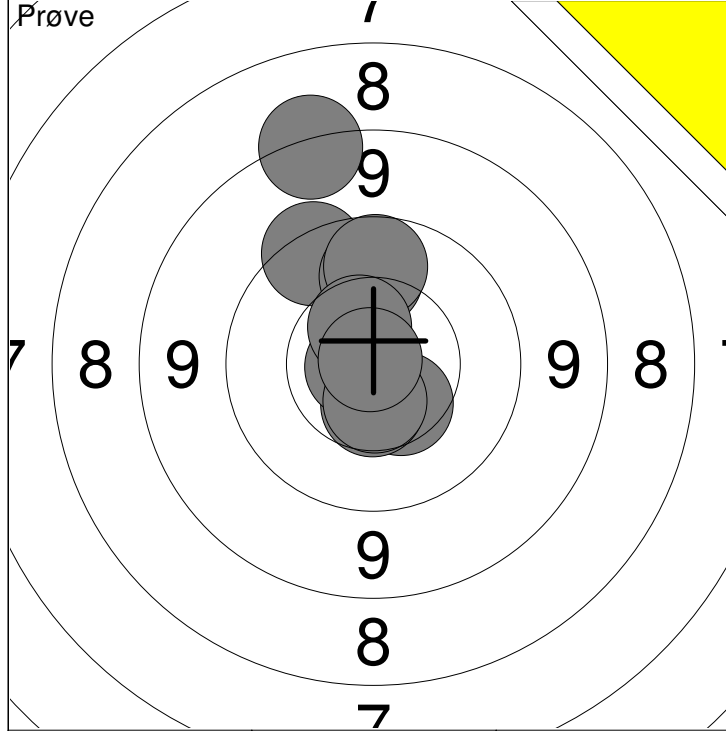

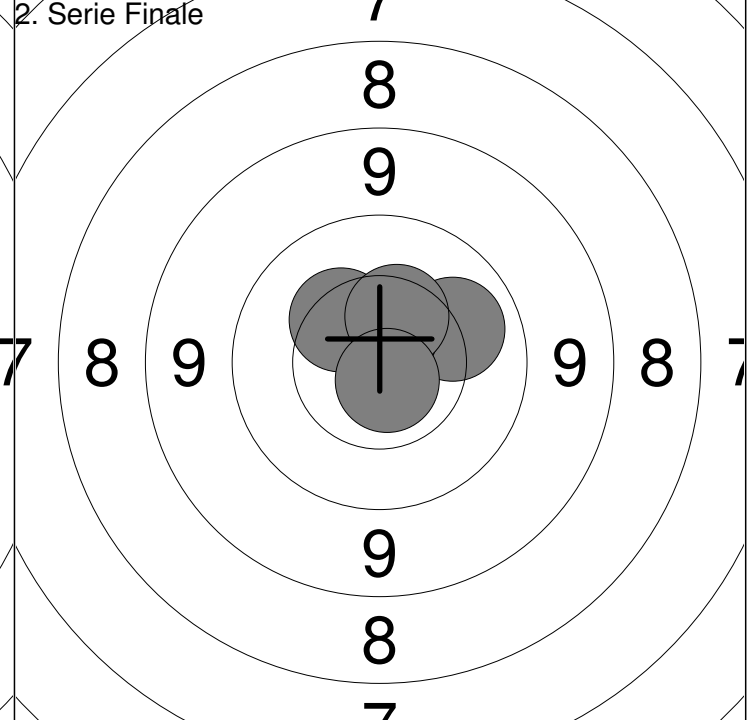
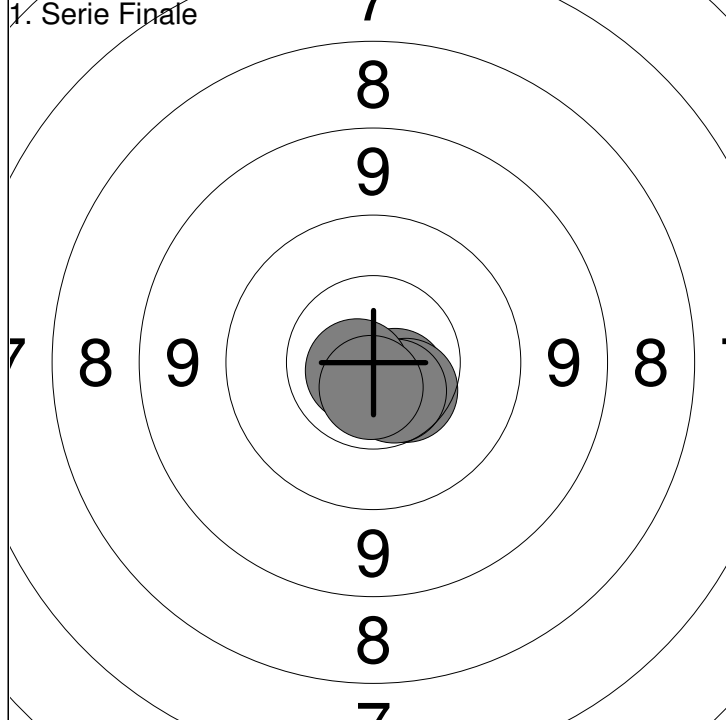

1: 8.4 ↗	6: 9.9 ↑	Serie	101.6
2: 9.6 ↗	7: 10.8x ←		
3: 10.4 ↘	8: 10.5 ↑	Total	399.0
4: 10.5 ↓	9: 10.6 ↓		
5: 10.0 ↑	10: 10.9x ↖		

11: 10.4 ←	Serie	10.4
	Total	399.0

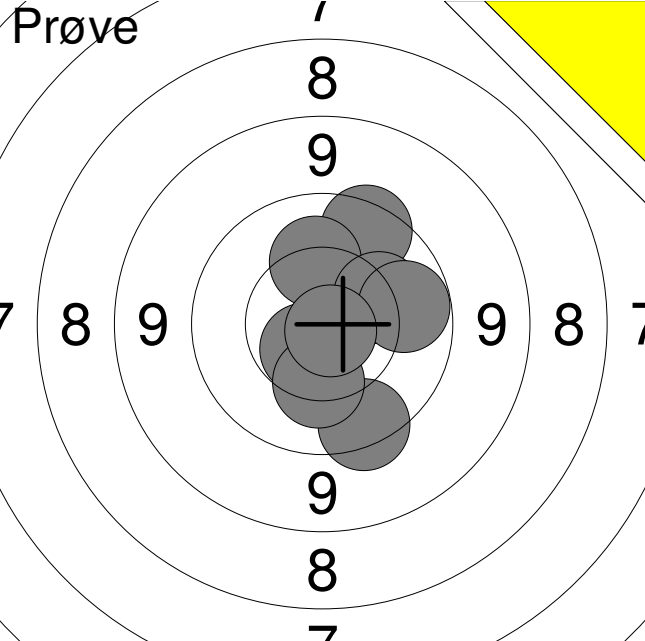
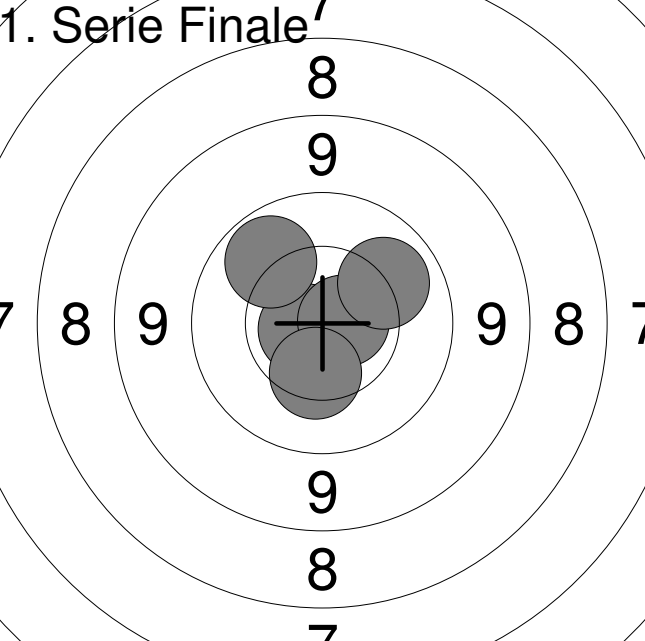

1: 10.6x ↘	Serie	53.2
2: 10.5 ↘		
3: 10.6 ↘	Total	452.2
4: 10.8x ←		
5: 10.7x ↓		

1: 10.1 ↗	Serie	52.2
2: 10.7x ↑		
3: 10.3 ↖	Total	504.4
4: 10.4 ↑		
5: 10.7x ↓		

Hold 7	Skive 4	Rasmus Møller Larsen		
Aalborg		Vilsted Skytteforening		Åben L
02.03.2018		Nordjysk mesterskab Finaler		Aalborg Skyttekreds
Prøve				
		1:	9.7	↗
		2:	10.2	↑
		3:	10.2	↗
		4:	10.0	→
		5:	10.6x	↘
		6:	9.6	↘
		7:	10.3	↓
		8:	10.8x	↘
		Serie		81.4
		Total		398.0
1. Serie Finale				
		1:	10.7x	←
		2:	10.7x	→
		3:	10.4	↓
		4:	10.0	↗
		5:	10.1	↗
		Serie		51.9
		Total		449.9
2. Serie Finale				
		1:	10.4	↓
		2:	10.6x	←
		3:	10.5	→
		4:	10.6x	↘
		5:	10.2	↗
		Serie		52.3
		Total		502.2

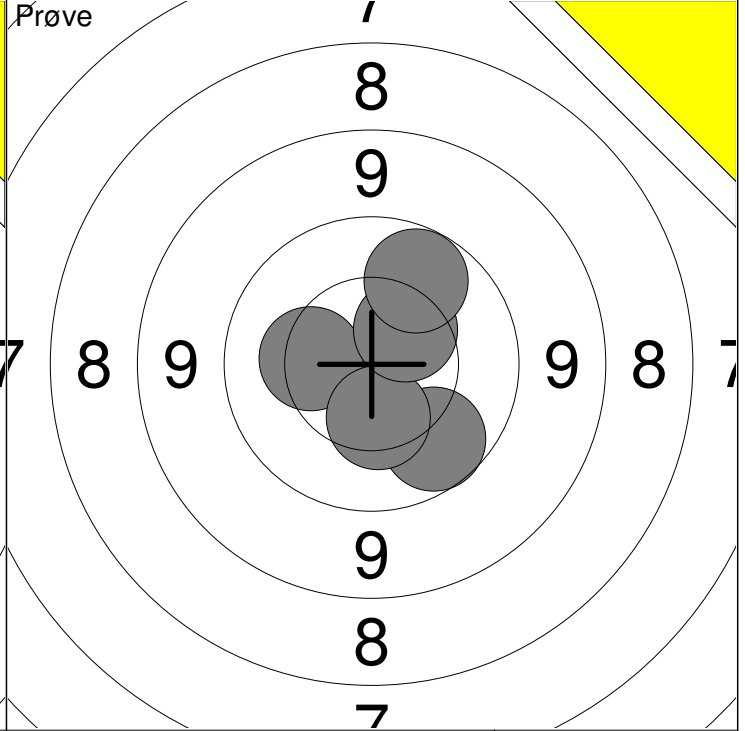
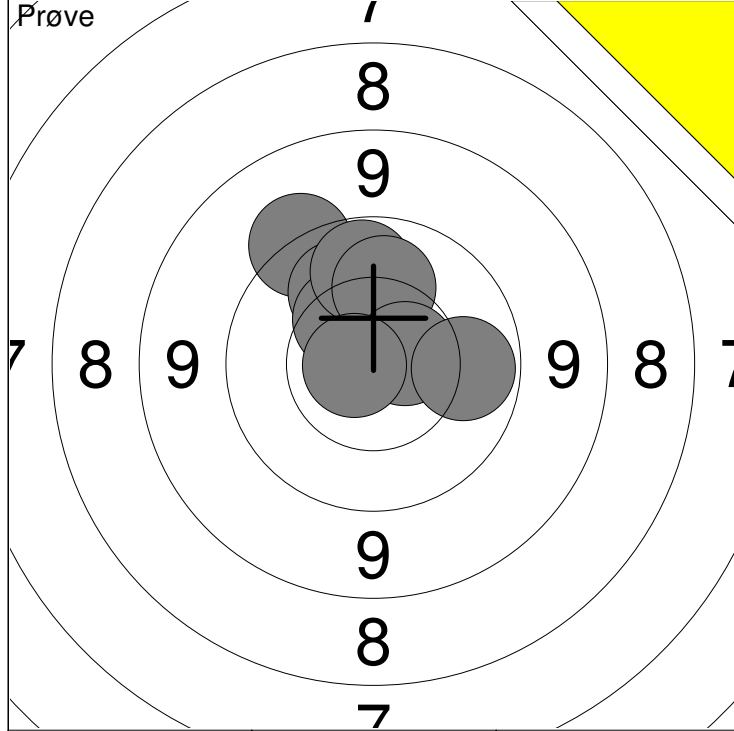

1: 9.5 ↖	6: 10.0 ↑	Serie 102.5
2: 10.3 ↑	7: 10.1 ↑	
3: 10.7x ↑	8: 10.6x →	Total 398.0
4: 10.1 ↖	9: 10.0 →	
5: 10.4 ↖	10: 10.8x ←	

11: 9.9 ↘	Serie 51.0
12: 10.3 ←	
13: 10.4 ↓	Total 398.0
14: 10.4 ↗	
15: 10.0 ↗	

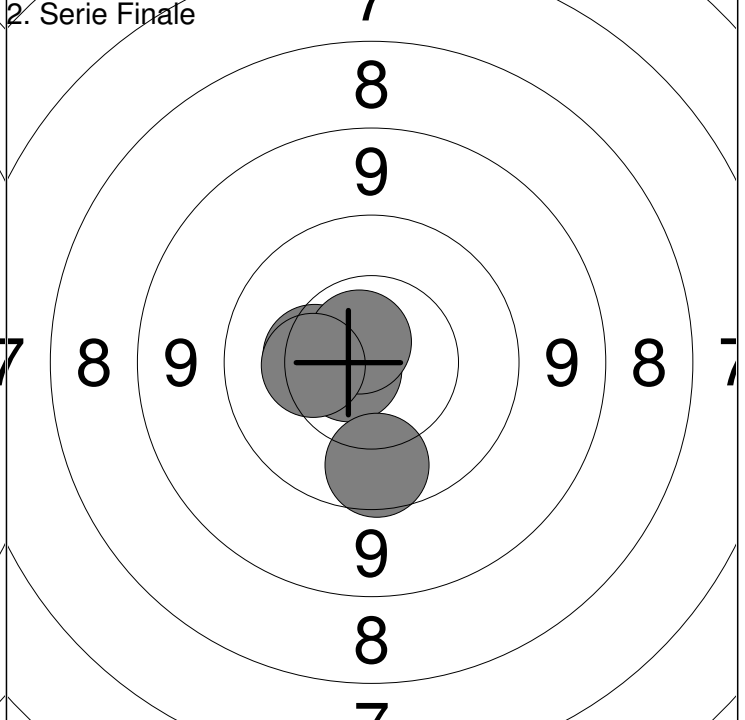
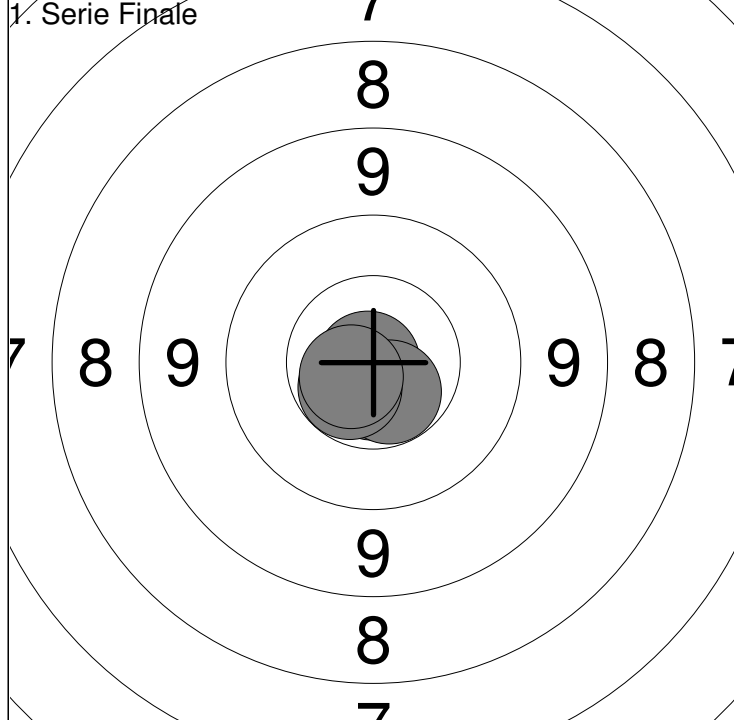

1: 10.7x ↓	Serie 53.5
2: 10.9x ←	
3: 10.6x ↓	Total 451.5
4: 10.6x ↖	
5: 10.7x ↖	

1: 10.3 ←	Serie 51.9
2: 10.7x ←	
3: 9.9 ↓	Total 503.4
4: 10.7x ↗	
5: 10.3 ←	

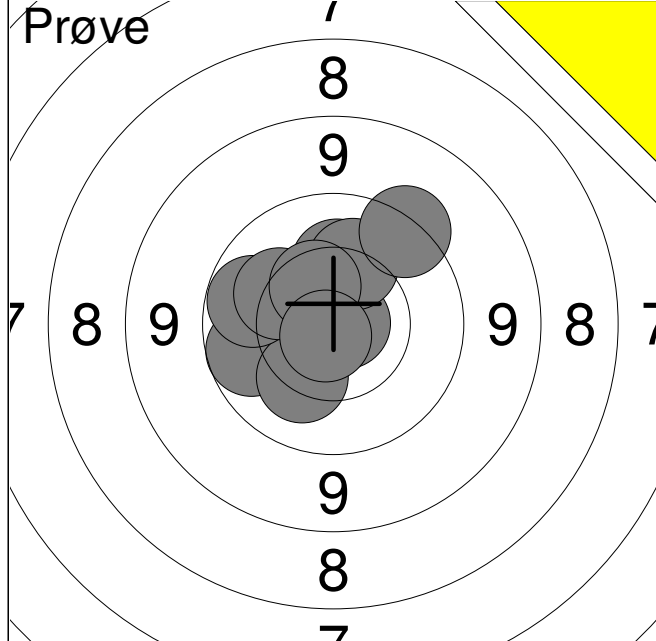

1:	9.9	←
2:	10.2	↓
3:	10.0	←
4:	10.2	↖
5:	10.8x	→
6:	10.2	↑
7:	10.2	↑
8:	10.5	↖
9:	10.8x	↓
10:	9.5	↗
Serie		102.3
Total		398.0



1:	10.5	↗
2:	10.2	↗
3:	10.8x	←
4:	10.3	↑
5:	10.4	↗
Serie		52.2
Total		450.2

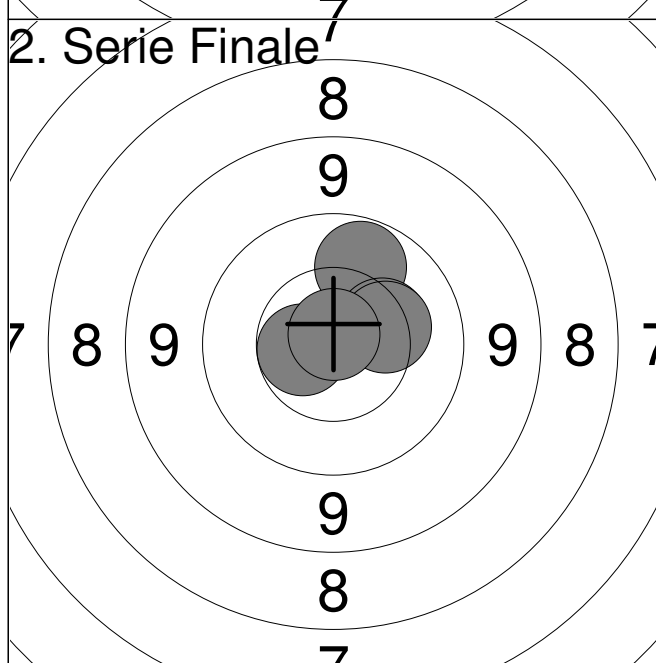

1:	10.0	↑
2:	10.3	↗
3:	10.3	↗
4:	10.6	←
5:	10.8x	↑
Serie		52.0
Total		502.2

Hold 7	Skive 9	Anne Lise Herskind	
------------------	-------------------	---------------------------	--

Aalborg	Vodskov Skytteforening	Åben	L
---------	------------------------	------	---

02.03.2018	Nordjysk mesterskab Finaler	Aalborg Skyttekreds	
------------	-----------------------------	---------------------	--

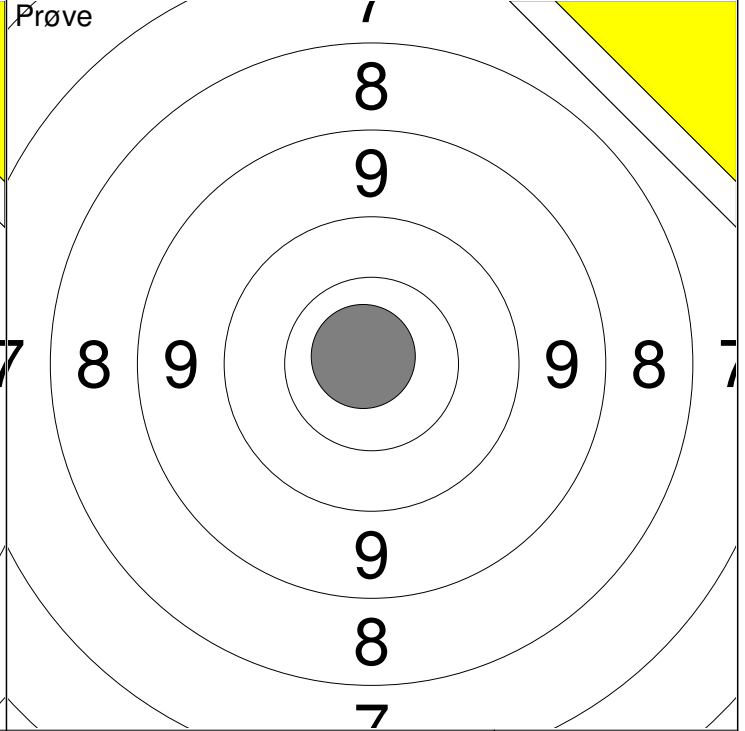
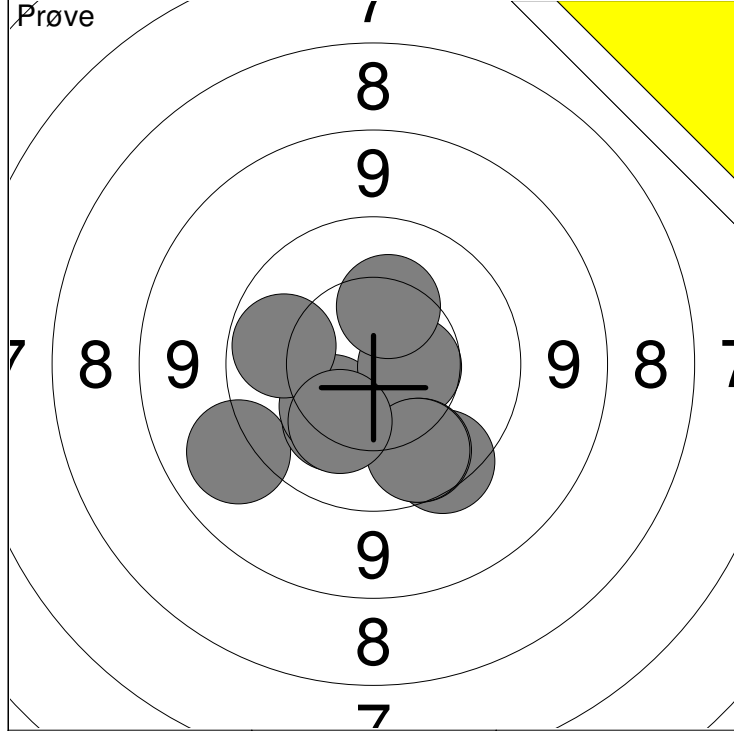

1: 9.2 ↙	6: 9.9 ↘	Serie	100.4
2: 10.2 ↘	7: 9.9 ↘		
3: 10.3 ↙	8: 10.0 ←	Total	398.0
4: 9.7 ↘	9: 10.3 ↘		
5: 10.6 →	10: 10.3 ↑		

11: 10.8x ↙	Serie	10.8
	Total	398.0

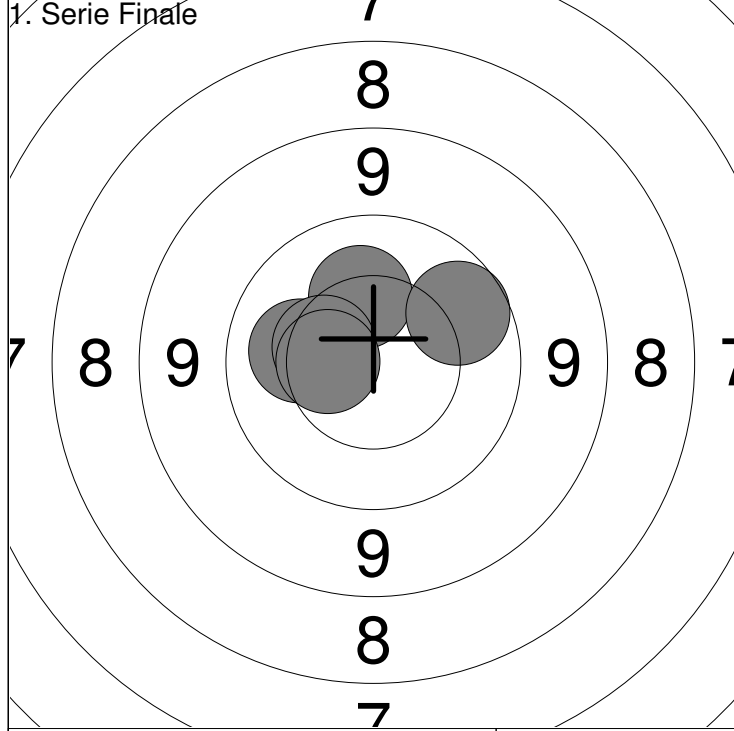

1: 10.3 ↑	Serie	51.3
2: 10.2 ←		
3: 10.4 ←	Total	449.3
4: 9.9 ↗		
5: 10.5 ←		

1: 10.1 ↘	Serie	52.0
2: 10.4 ↑		
3: 10.7x ↗	Total	501.3
4: 10.8x ←		
5: 10.0 ↙		

Hold 7	Skive 10	Ole H. Madsen
------------------	--------------------	----------------------

Aalborg	Frederikshavn Skyttekreds	Åben	L
---------	---------------------------	------	---

02.03.2018	Nordjysk mesterskab Finaler	Aalborg Skyttekreds
------------	-----------------------------	---------------------

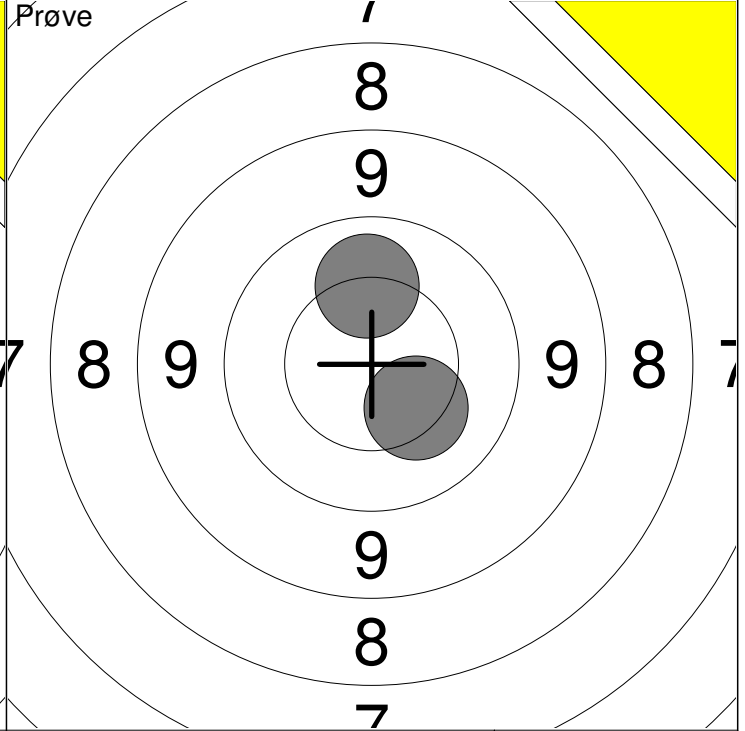
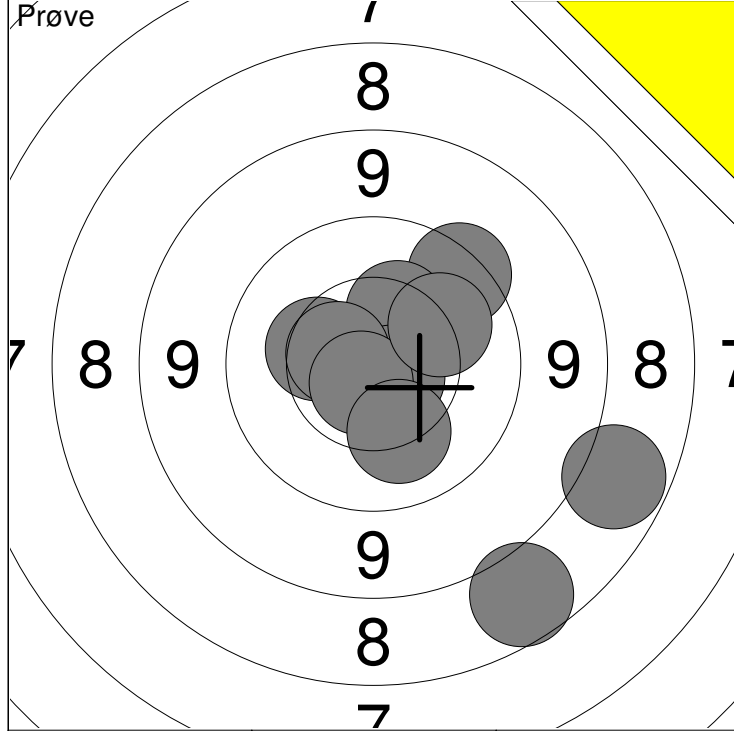

1: 7.9 ↘	6: 10.7x ↘	Serie	98.5
2: 8.0 ↗	7: 10.6 ←		
3: 9.6 ↗	8: 10.7x ↘	Total	398.0
4: 10.3 ←	9: 10.1 ↗		
5: 10.4 ↗	10: 10.2 ↘		

11: 10.1 ↑	Serie	20.4
12: 10.3 ↘		
	Total	398.0

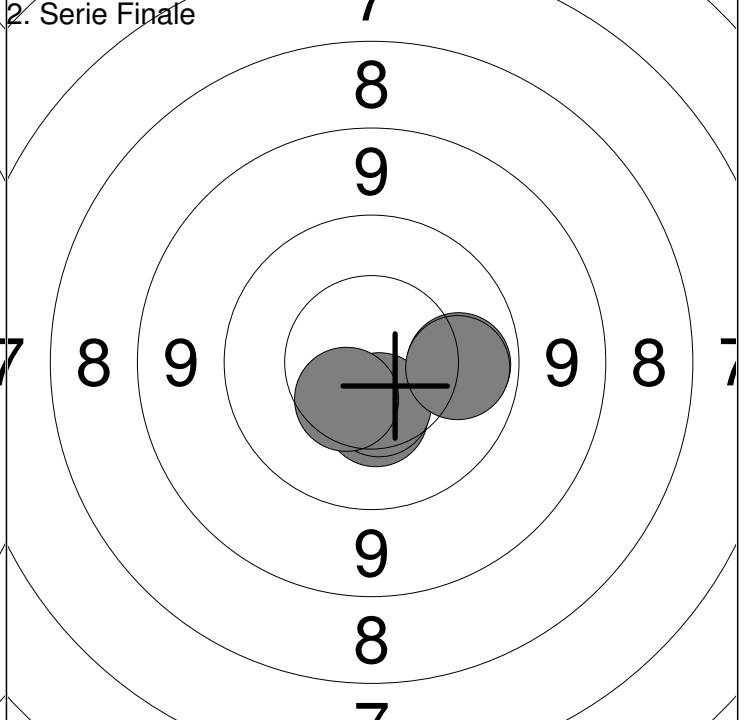
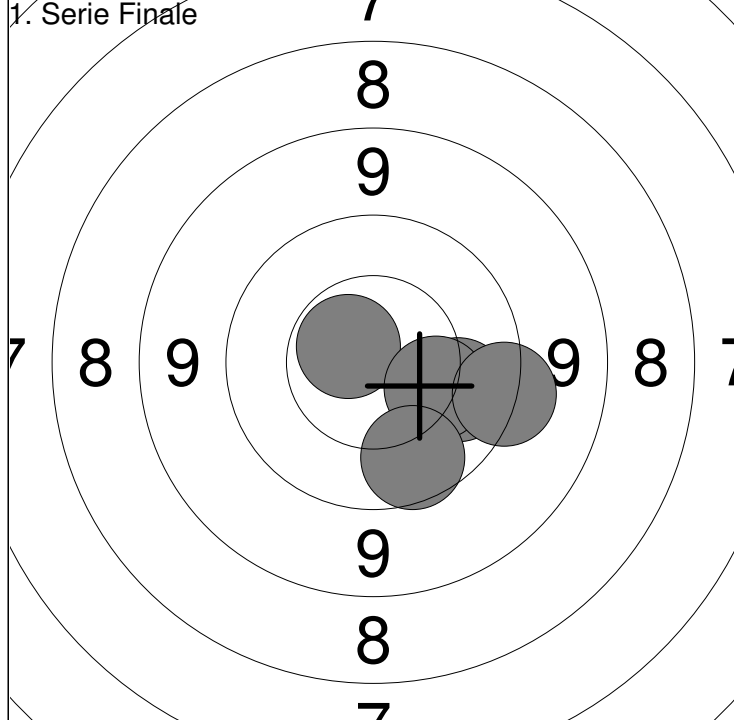

1: 10.6x ↗	Serie	50.2
2: 10.0 ↗		
3: 10.2 ↗	Total	448.2
4: 9.5 ↗		
5: 9.9 ↘		

1: 10.0 →	Serie	51.4
2: 10.4 ↘		
3: 10.5 ↘	Total	499.6
4: 10.0 →		
5: 10.5 ↘		

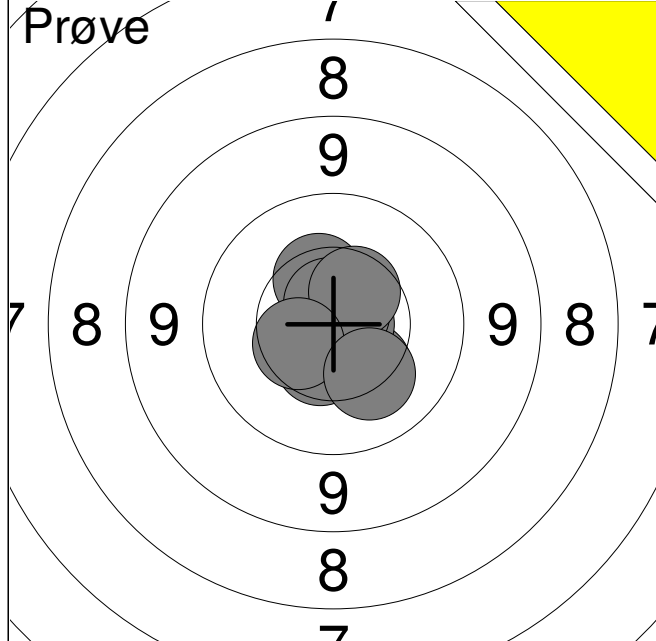

1:	10.3	↘
2:	10.8x	→
3:	10.8x	↗
4:	10.7x	↑
5:	10.4	↑
6:	10.7x	↑
7:	10.5	↘
8:	10.5	↗
9:	10.5	↙
10:	10.2	↘
Serie		105.4
Total		398.0

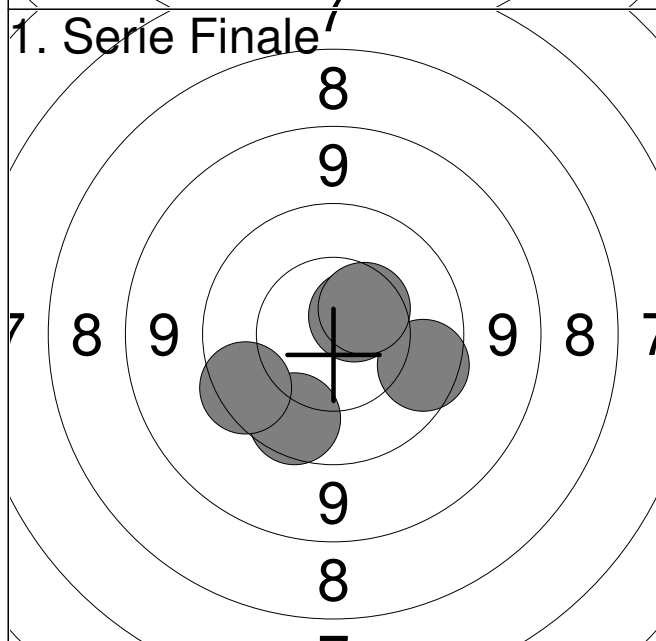

1:	9.8	↘
2:	9.7	↙
3:	10.6x	↗
4:	9.8	→
5:	10.5	↗
Serie		50.4
Total		448.4

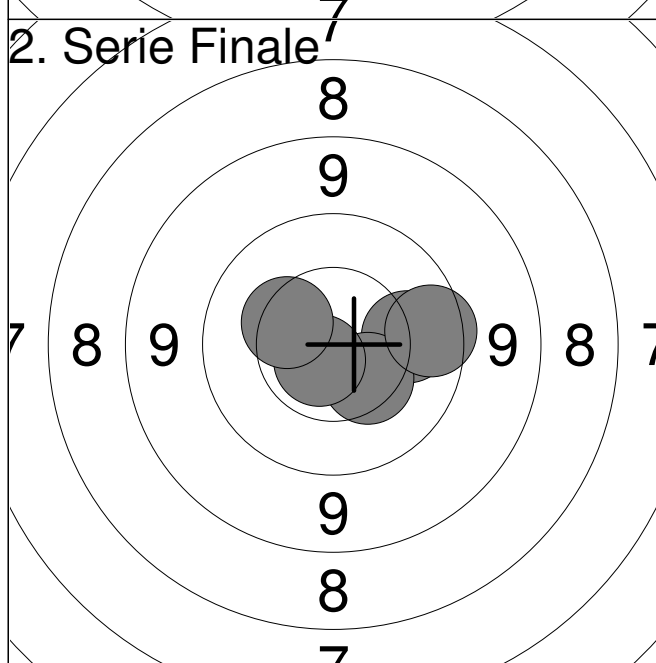

1:	10.1	→
2:	10.4	↘
3:	9.8	→
4:	10.7x	↘
5:	10.3	↙
Serie		51.3
Total		499.7

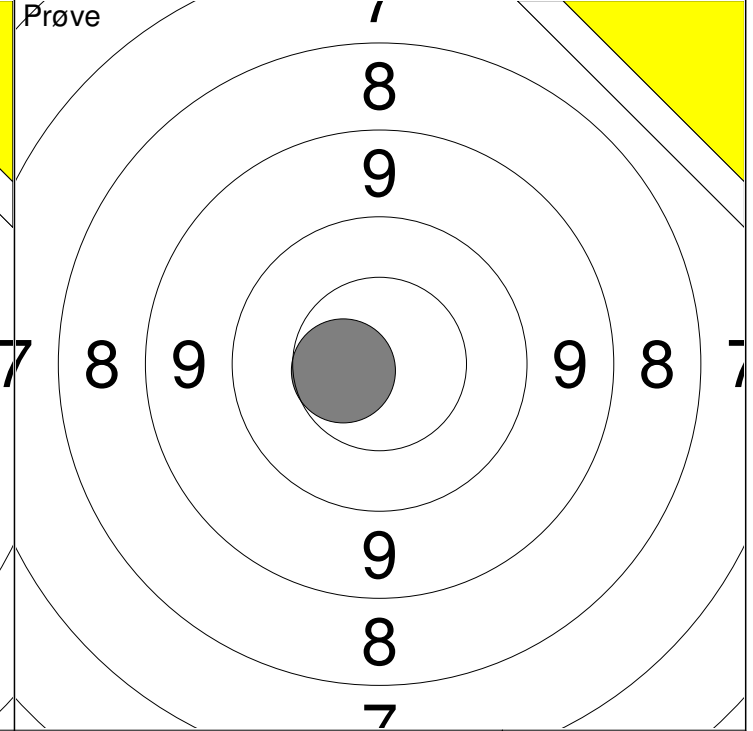
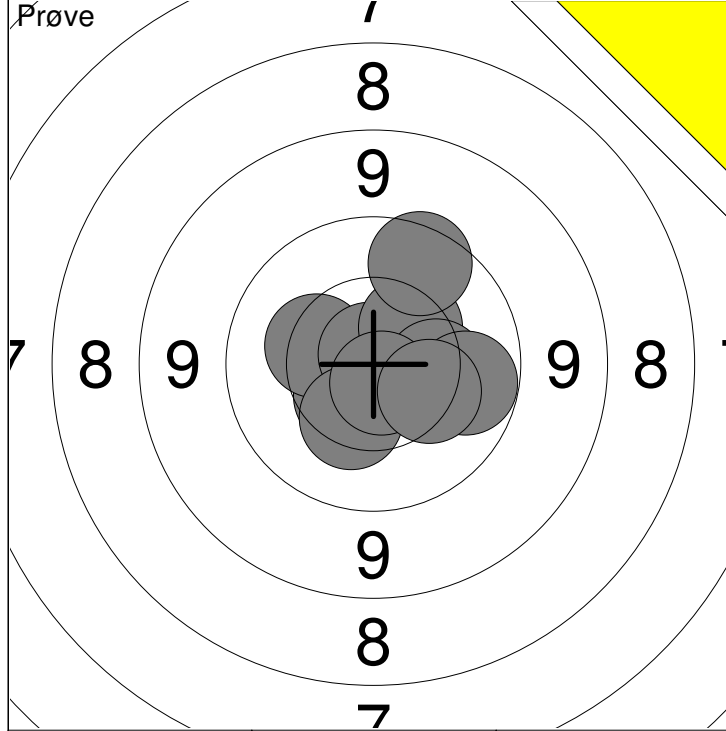

1: 10.5 ↙	6: 10.3 →	Serie 103.4
2: 10.3 ↖	7: 10.3 ↓	
3: 10.8x ↗	8: 10.0 →	Total 397.0
4: 10.4 ↗	9: 10.7x ↓	
5: 9.8 ↗	10: 10.3 ↘	

11: 10.6 ←	Serie 10.6
	Total 397.0

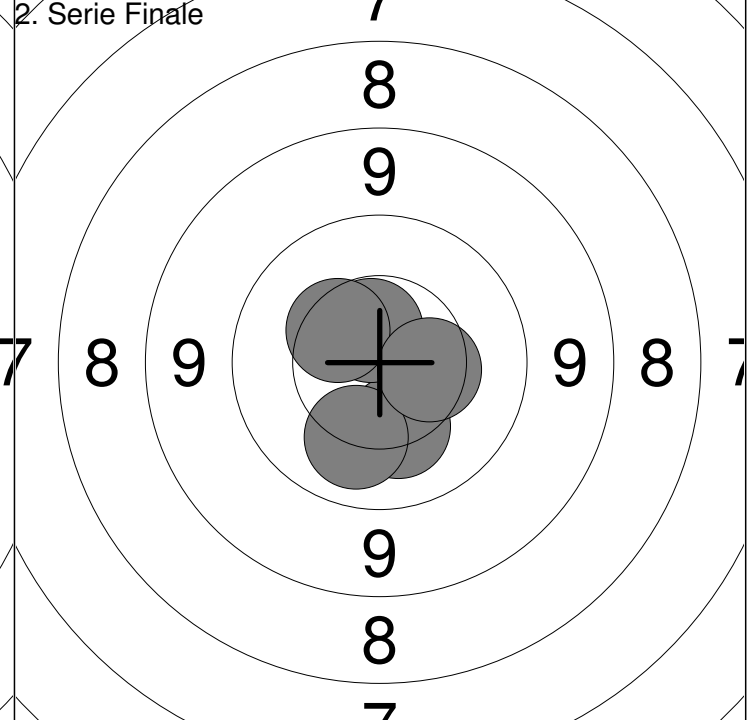
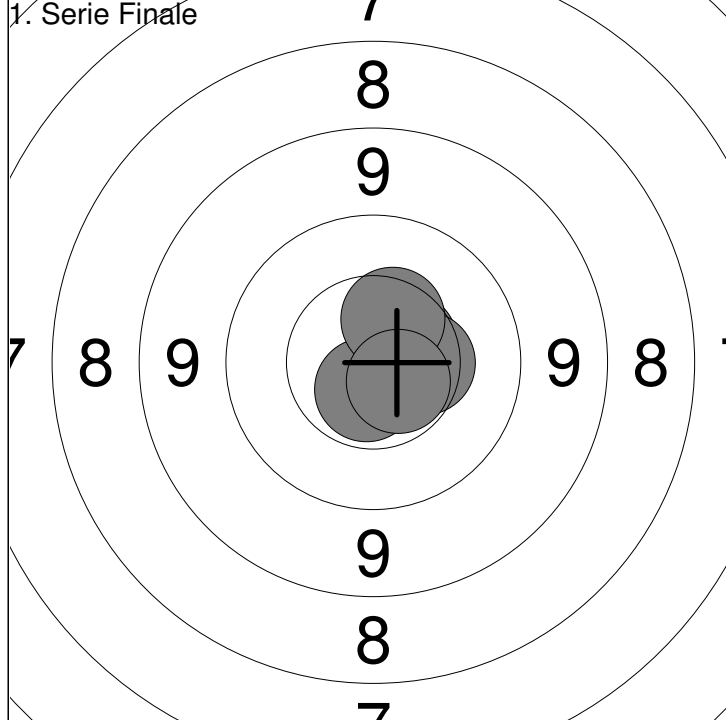

1: 10.6 ↗	Serie 52.8
2: 10.7x ↓	
3: 10.4 →	Total 449.8
4: 10.5 ↗	
5: 10.6x ↘	

1: 10.2 ↓	Serie 51.7
2: 10.6x ↗	
3: 10.1 ↓	Total 501.5
4: 10.4 ↗	
5: 10.4 →	

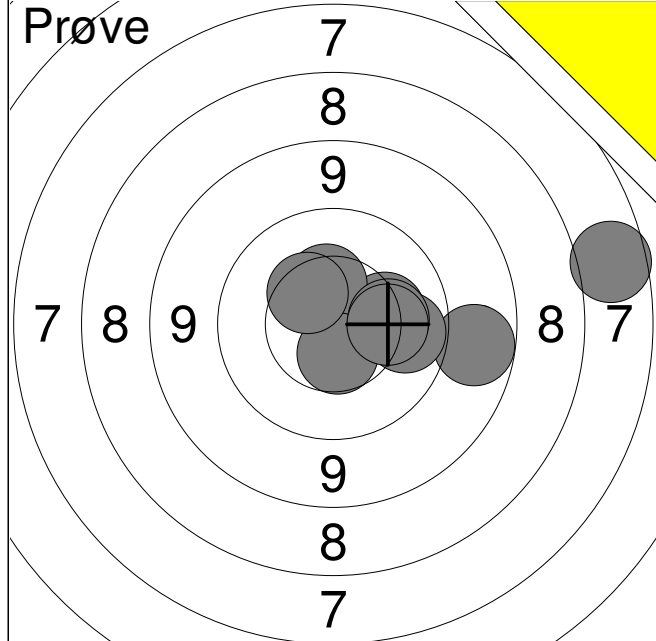

1:	10.2	→
2:	6.9	→
3:	9.0	→
4:	10.0	→
5:	10.4	↑
6:	10.5	↓
7:	10.4	↗
8:	10.2	→
9:	10.2	→

Serie	87.8
-------	------

Total	382.0
-------	-------

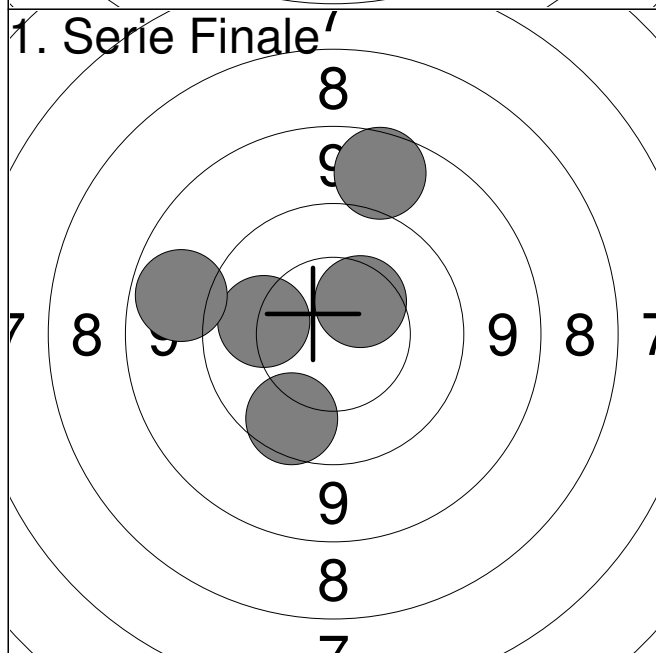

1:	10.1	←
2:	8.9	↑
3:	10.4	↗
4:	9.0	←
5:	9.8	↓

Serie	48.2
-------	------

Total	430.2
-------	-------

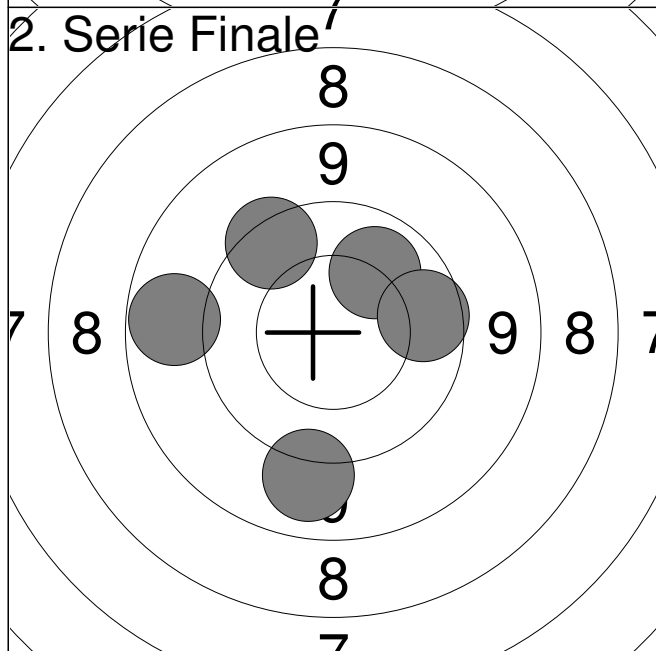

1:	10.1	↗
2:	9.6	↖
3:	9.9	→
4:	9.0	←
5:	9.2	↓

Serie	47.8
-------	------

Total	478.0
-------	-------

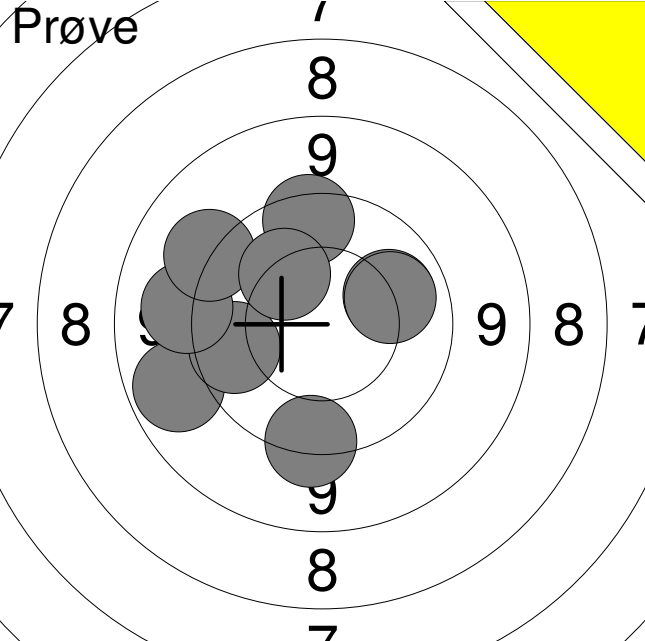
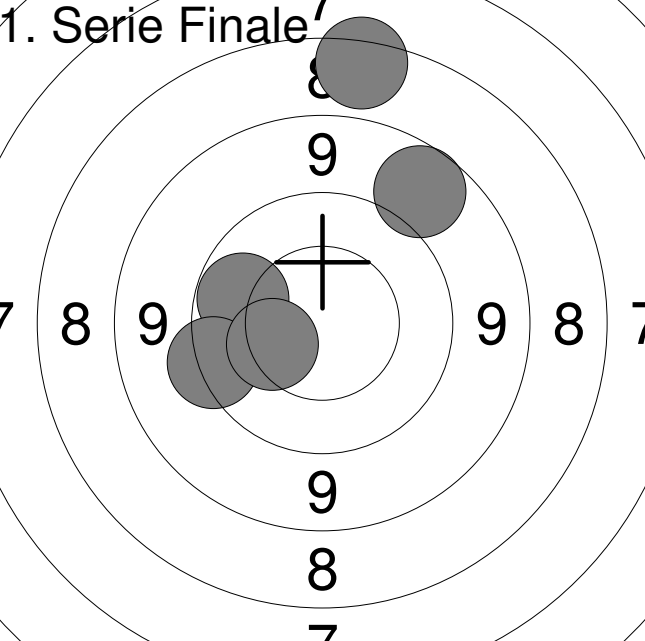
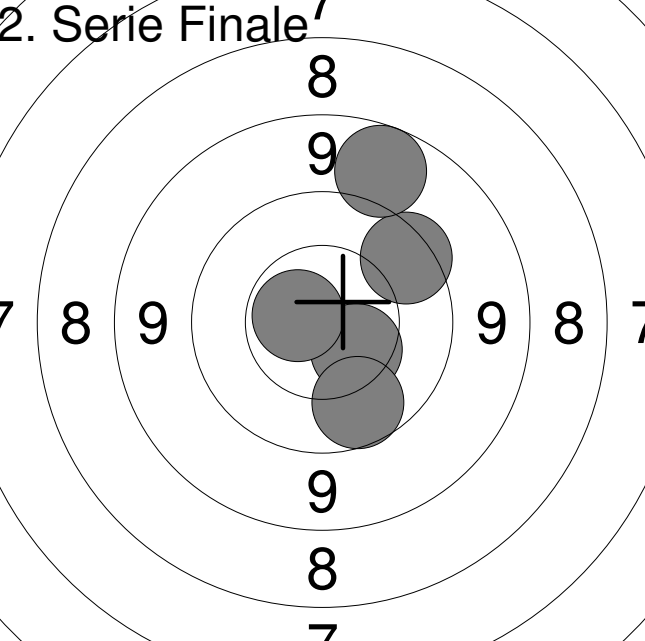
Hold 8	Skive 2	Anton Christensen		
Aalborg		Frederikshavn Skyttekreds		Stilling L
02.03.2018		Nordjysk mesterskab Finaler		Aalborg Skyttekreds
Prøve				
		1:	9.0	←
		2:	9.9	←
		3:	9.3	←
		4:	9.5	↓
		5:	9.7	↑
		6:	9.3	↖
		7:	10.1	↗
		8:	10.2	↖
		9:	10.1	↗
		Serie		87.1
		Total		381.0
1. Serie Finale				
		1:	7.6	↑
		2:	10.0	←
		3:	8.9	↗
		4:	9.5	←
		5:	10.3	←
		Serie		46.3
		Total		427.3
2. Serie Finale				
		1:	10.4	↘
		2:	9.7	↗
		3:	10.7x	←
		4:	8.9	↑
		5:	9.9	↓
		Serie		49.6
		Total		476.9

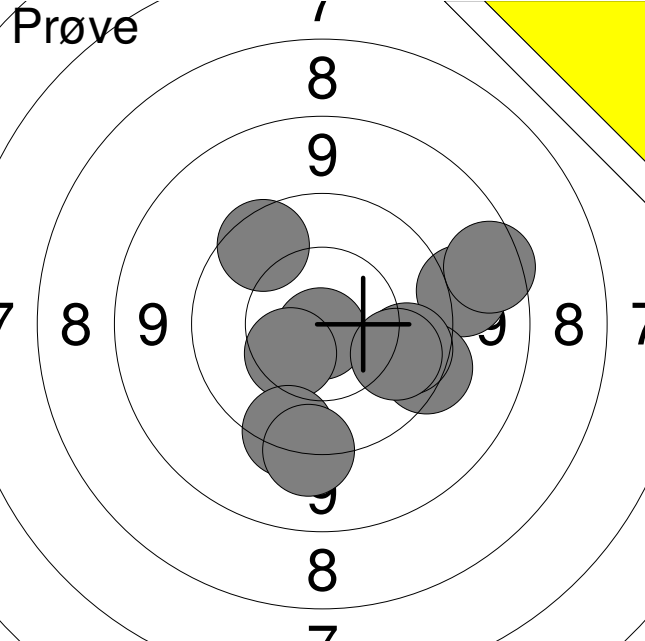
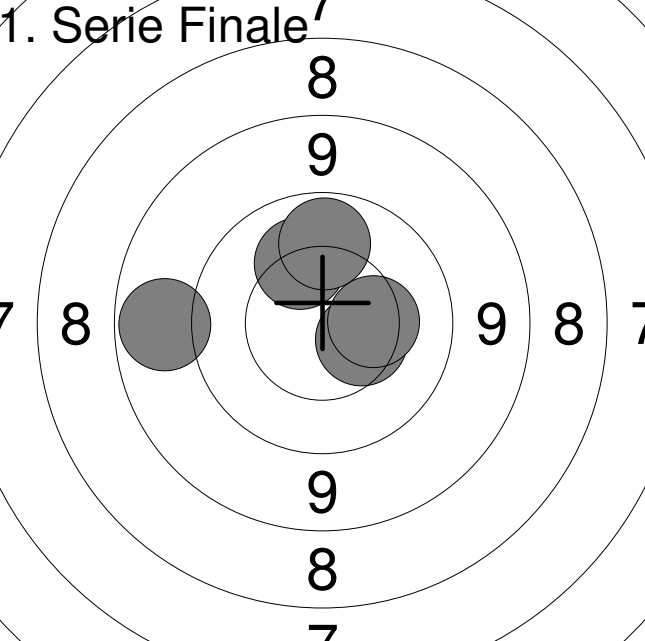
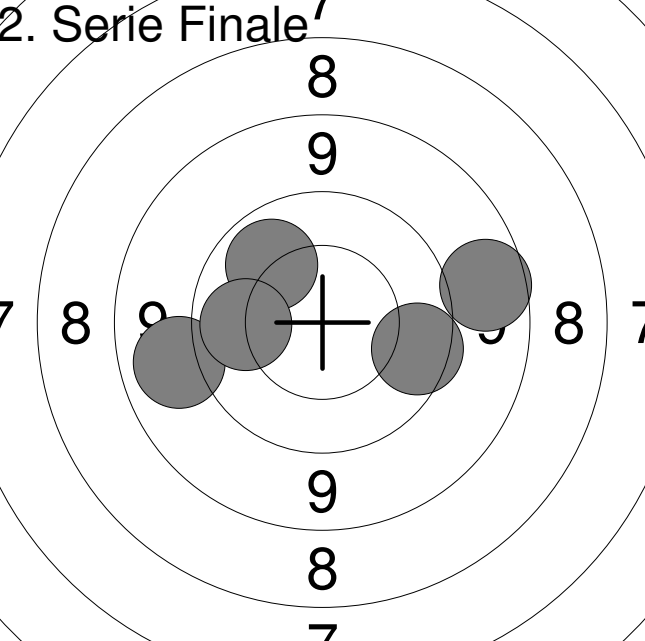
Hold 8	Skive 3	Sofie Frantsen		
Aalborg		Bjergby SGI&U		Stilling L
02.03.2018		Nordjysk mesterskab Finaler		Aalborg Skyttekreds
Prøve				1: 10.8x ↓ 2: 9.2 → 3: 9.6 ↘ 4: 10.4 ↙ 5: 9.6 ↓ 6: 9.9 → 7: 9.4 ↓ 8: 8.8 → 9: 10.0 ↘ 10: 9.8 ↗
		Serie		97.5
		Total		380.0
1. Serie Finale				1: 10.4 ↘ 2: 10.2 ↑ 3: 10.3 → 4: 9.0 ← 5: 10.0 ↑
		Serie		49.9
		Total		429.9
2. Serie Finale				1: 8.9 → 2: 10.0 ↗ 3: 9.8 ↘ 4: 9.1 ← 5: 10.0 ←
		Serie		47.8
		Total		477.7

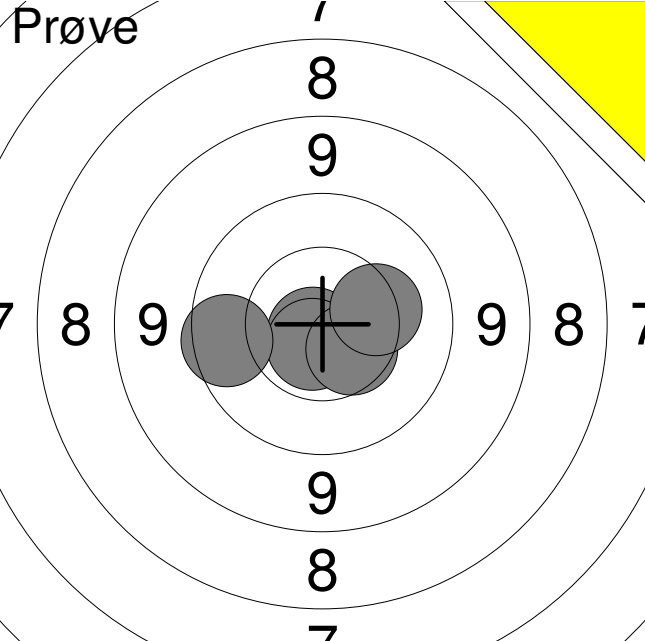
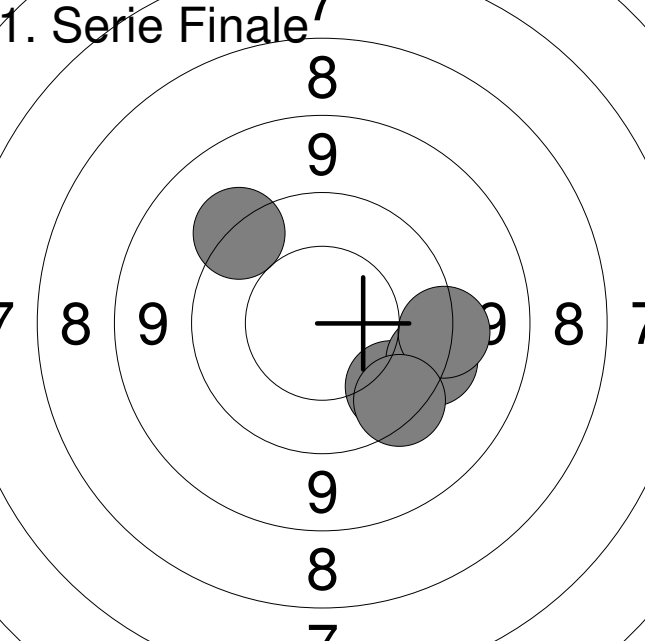
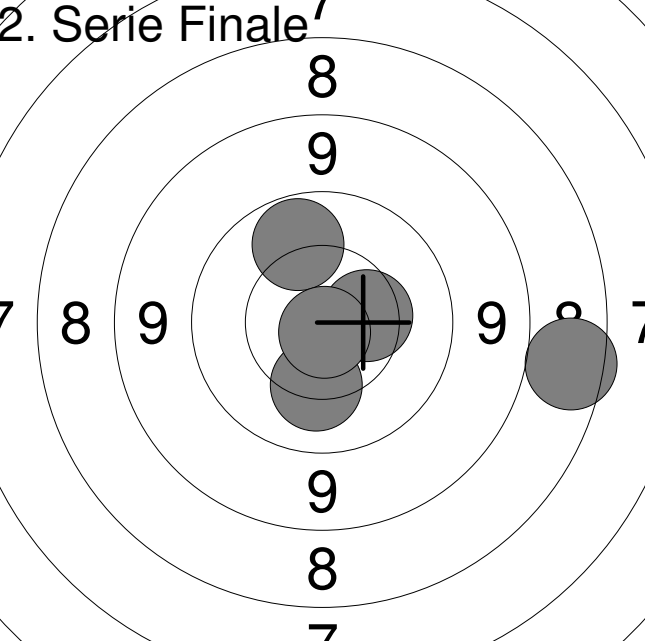
Hold 8	Skive 4	Stefan Olsen		
Aalborg		Aalborg Skyttekreds		Stilling L
02.03.2018		Nordjysk mesterskab Finaler		Aalborg Skyttekreds
Prøve				
		1: 10.8x ↙ 2: 10.7x ↓ 3: 10.5 ↘ 4: 10.3 → 5: 9.8 ←		
		Serie		52.1
		Total		380.0
1. Serie Finale				
		1: 9.8 ↘ 2: 9.5 → 3: 9.5 → 4: 9.6 ↘ 5: 9.5 ↗		
		Serie		47.9
		Total		427.9
2. Serie Finale				
		1: 10.0 ↑ 2: 7.8 → 3: 10.4 → 4: 10.2 ↓ 5: 10.8x ↓		
		Serie		49.2
		Total		477.1

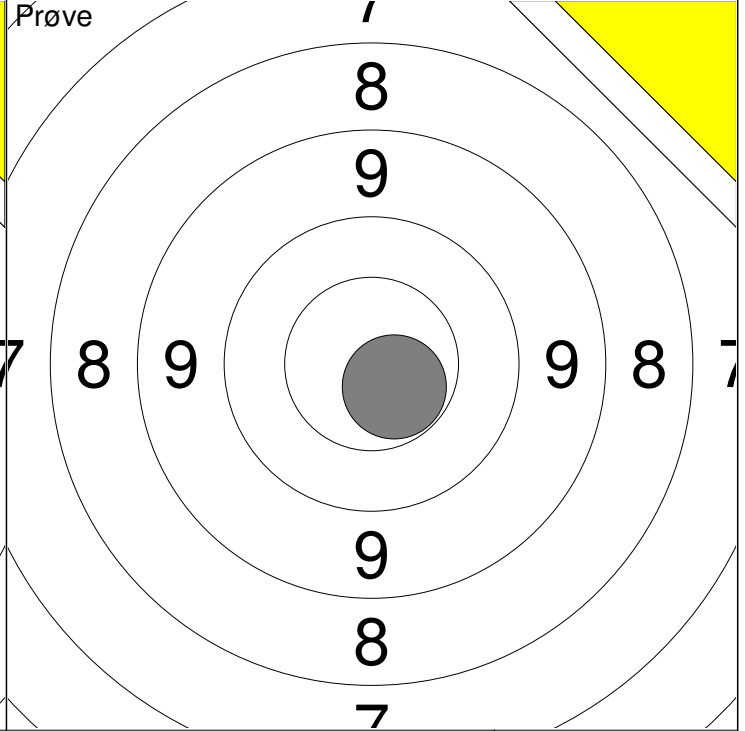
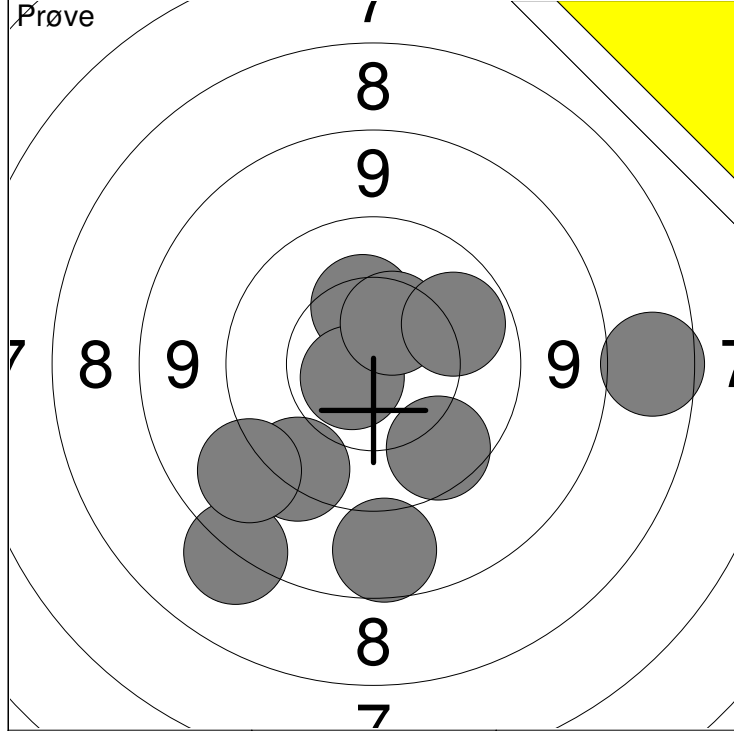

1: 10.3 ↑	6: 8.9 ↓	Serie 95.2
2: 7.8 →	7: 8.4 ↘	
3: 10.7x ↙	8: 9.2 ↙	Total 380.0
4: 9.6 ↘	9: 9.8 ↘	
5: 10.5 ↑	10: 10.0 ↗	

11: 10.6x ↘	Serie 10.6
	Total 380.0

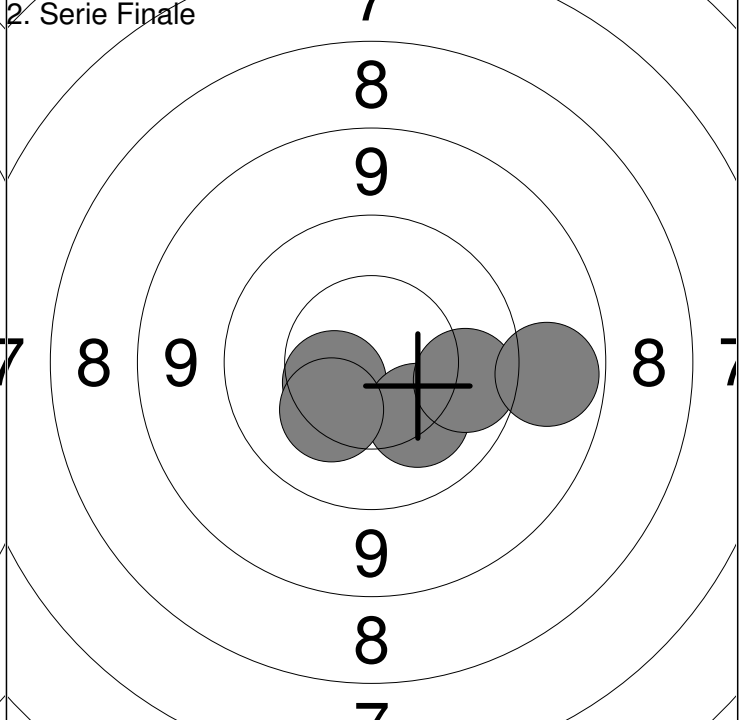
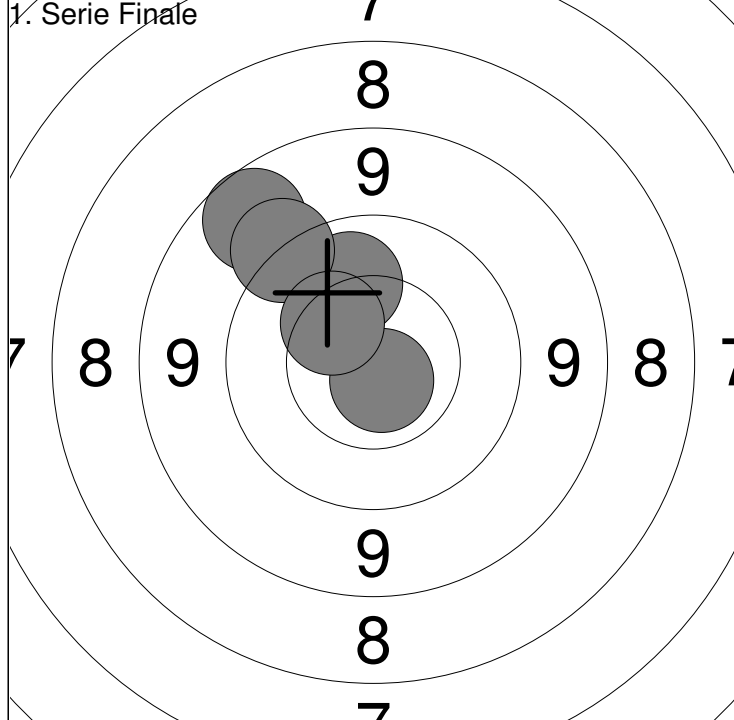

1: 10.7x ↘	Serie 49.5
2: 10.1 ↗	
3: 8.9 ↗	Total 429.5
4: 9.4 ↗	
5: 10.4 ↗	

1: 10.5 ↙	Serie 50.0
2: 10.2 ↘	Total 479.5
3: 10.0 →	
4: 9.0 →	
5: 10.3 ↘	

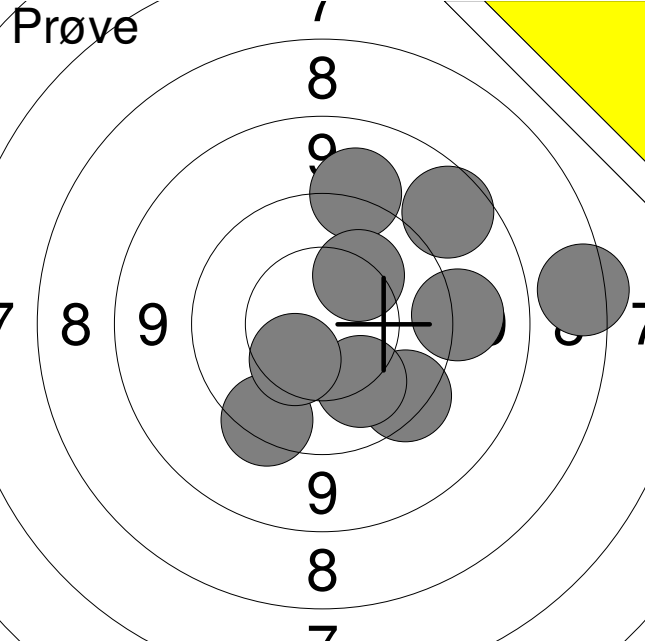
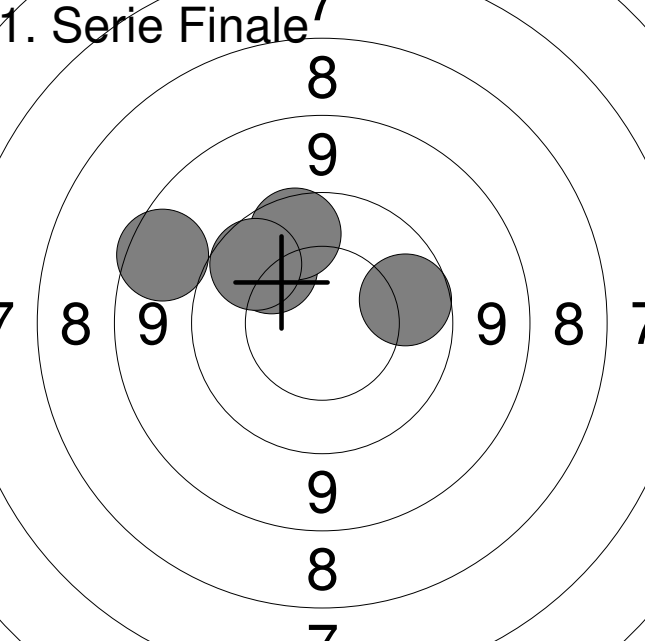
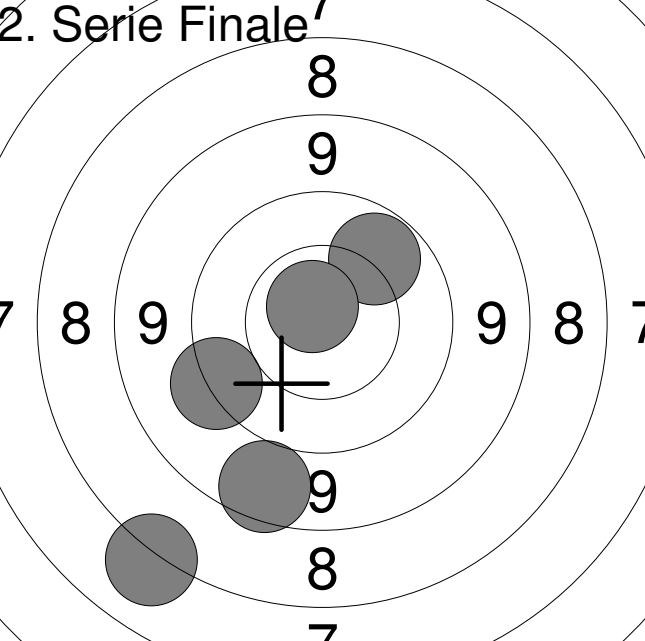
Hold 8	Skive 7	Annette Munkbøl		
Aalborg		Aalborg Skyttekreds		Stilling L
02.03.2018		Nordjysk mesterskab Finaler		Aalborg Skyttekreds
Prøve				
		1:	9.6	↙
		2:	9.6	↘
		3:	10.1	↘
		4:	8.9	↗
		5:	9.3	→
		6:	9.3	↑
		7:	10.4	↙
		8:	7.6	→
		9:	10.2	↗
		Serie		85.0
		Total		368.0
1. Serie Finale				
		1:	10.1	↗
		2:	9.9	→
		3:	9.8	↑
		4:	8.8	↖
		5:	9.9	↗
		Serie		48.5
		Total		416.5
2. Serie Finale				
		1:	10.0	↗
		2:	9.5	↖
		3:	8.8	↘
		4:	10.7x	↗
		5:	7.3	↘
		Serie		46.3
		Total		462.8

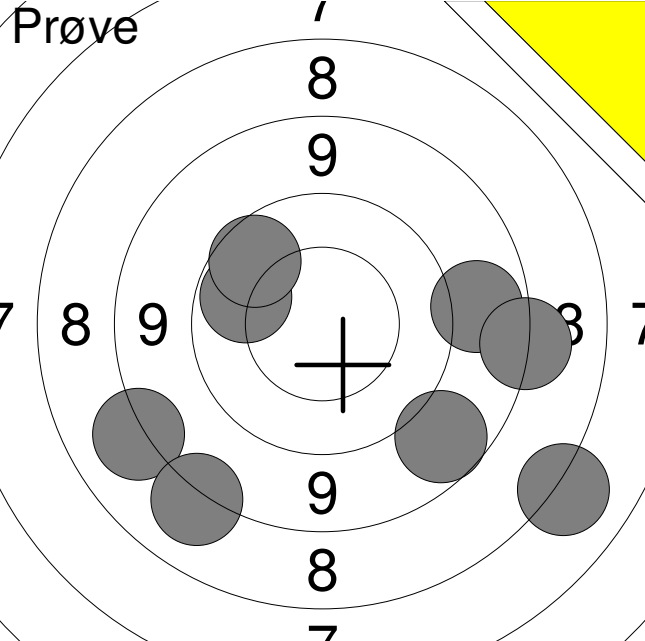
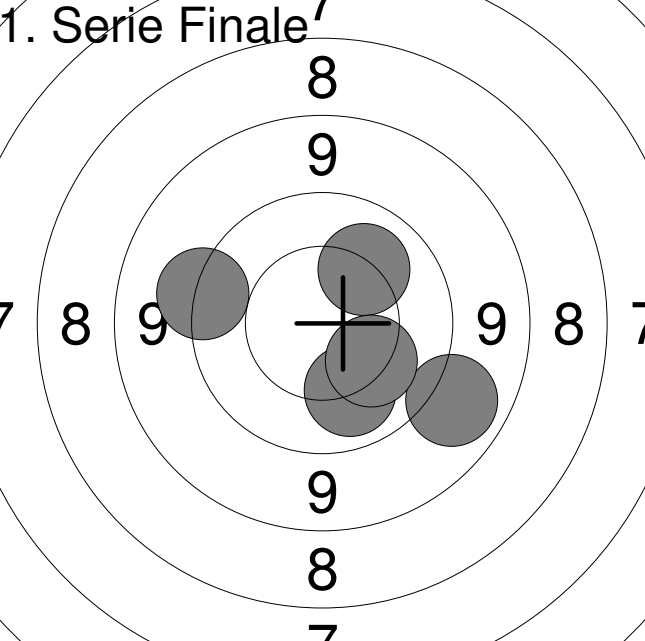
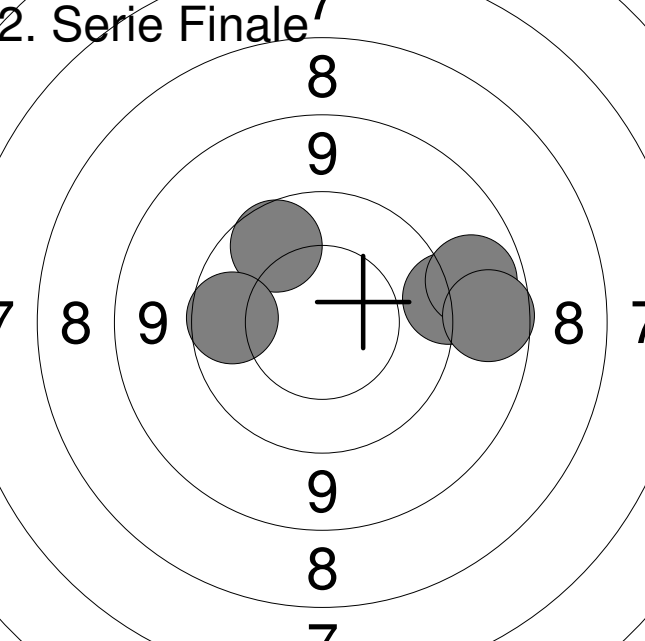
Hold 8	Skive 11	Dennis Nielsen		
Aalborg		Vodskov Skytteforening		Stilling L
02.03.2018		Nordjysk mesterskab Finaler		Aalborg Skyttekreds
Prøve				
		1: 8.3 ↙ 2: 8.2 ↘ 3: 10.0 ↖ 4: 7.2 ↘ 5: 9.0 → 6: 8.9 ↘ 7: 9.9 ↗ 8: 8.4 →		
		Serie 69.9		
		Total 362.0		
1. Serie Finale				
		1: 10.1 ↘ 2: 9.1 ↘ 3: 9.5 ↖ 4: 10.1 ↗ 5: 10.2 ↘		
		Serie 49.0		
		Total 411.0		
2. Serie Finale				
		1: 9.9 ↗ 2: 9.4 → 3: 9.9 ← 4: 9.0 → 5: 8.9 →		
		Serie 47.1		
		Total 458.1		

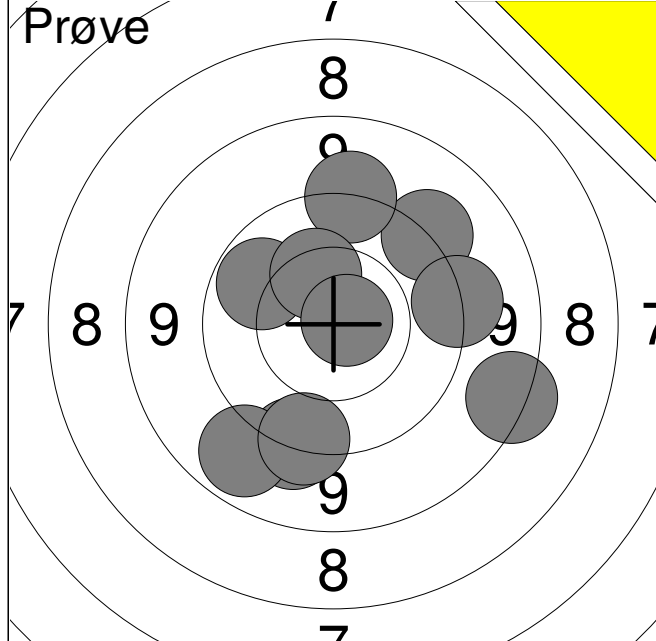

1:	9.4	↓
2:	8.5	→
3:	9.4	↗
4:	9.4	↑
5:	9.0	↓
6:	9.5	↓
7:	10.0	↖
8:	10.3	↑
9:	10.8x	→
10:	9.4	→

Serie	95.7
--------------	-------------

Total	362.0
--------------	--------------

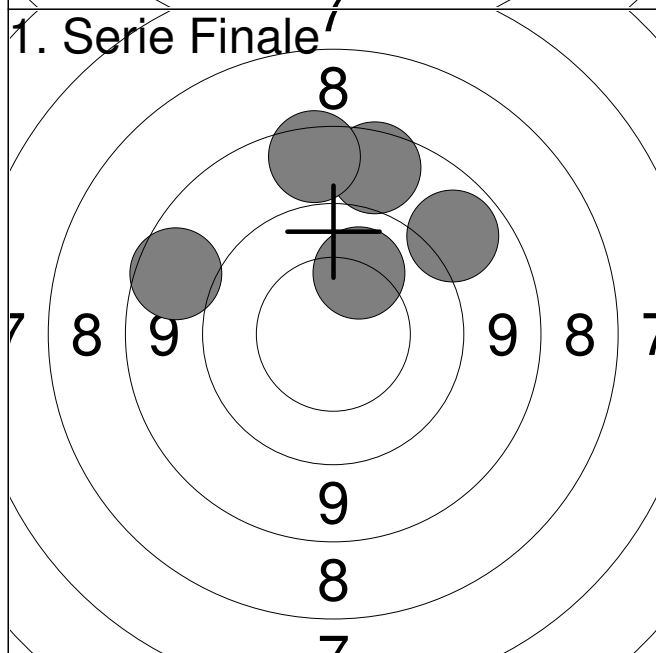

1:	8.8	↑
2:	10.2	↑
3:	8.9	↖
4:	8.7	↑
5:	9.0	↗

Serie	45.6
--------------	-------------

Total	407.6
--------------	--------------

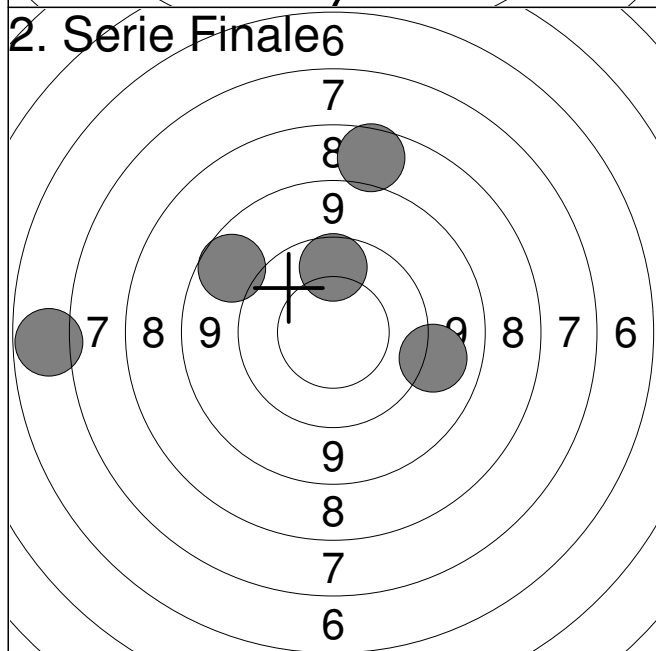

1:	9.9	↑
2:	6.0	←
3:	7.9	↑
4:	9.2	→
5:	8.9	↖

Serie	41.9
--------------	-------------

Total	449.5
--------------	--------------